

# PS20

## Personal Shopper



## Product Reference Guide for Android™ 9.0 Pie



**ZEBRA**

# Copyright

ZEBRA and the stylized Zebra head are trademarks of Zebra Technologies Corporation, registered in many jurisdictions worldwide. Google, Android, Google Play and other marks are trademarks of Google LLC. All other trademarks are the property of their respective owners. ©2021 Zebra Technologies Corporation and/or its affiliates. All rights reserved.

COPYRIGHTS & TRADEMARKS: For complete copyright and trademark information, go to [www.zebra.com/copyright](http://www.zebra.com/copyright).

WARRANTY: For complete warranty information, go to [www.zebra.com/warranty](http://www.zebra.com/warranty).

END USER LICENSE AGREEMENT: For complete EULA information, go to [www.zebra.com/eula](http://www.zebra.com/eula).

# Terms of Use

- Proprietary Statement

This manual contains proprietary information of Zebra Technologies Corporation and its subsidiaries (“Zebra Technologies”). It is intended solely for the information and use of parties operating and maintaining the equipment described herein. Such proprietary information may not be used, reproduced, or disclosed to any other parties for any other purpose without the express, written permission of Zebra Technologies.

- Product Improvements

Continuous improvement of products is a policy of Zebra Technologies. All specifications and designs are subject to change without notice.

- Liability Disclaimer

Zebra Technologies takes steps to ensure that its published Engineering specifications and manuals are correct; however, errors do occur. Zebra Technologies reserves the right to correct any such errors and disclaims liability resulting therefrom.

- Limitation of Liability

In no event shall Zebra Technologies or anyone else involved in the creation, production, or delivery of the accompanying product (including hardware and software) be liable for any damages whatsoever (including, without limitation, consequential damages including loss of business profits, business interruption, or loss of business information) arising out of the use of, the results of use of, or inability to use such product, even if Zebra Technologies has been advised of the possibility of such damages. Some jurisdictions do not allow the exclusion or limitation of incidental or consequential damages, so the above limitation or exclusion may not apply to you.

# Revision History

Changes to the original guide are listed below:

Change	Date	Description
-01 Rev A	07/2019	Initial release.
-02 Rev A	09/2021	Update GSM Restricted.

# Table of Contents

Copyright .....	2
Terms of Use .....	2
Revision History .....	2
<b>About This Guide .....</b>	<b>11</b>
Configurations .....	11
Notational Conventions .....	11
Service Information .....	12
Software Versions .....	12
<b>Getting Started .....</b>	<b>13</b>
Unpacking .....	13
Removing the Screen Protection Film .....	13
Features .....	14
Status LED .....	15
Scan Key .....	16
Setting Up the Device .....	17
Charging the Battery .....	17
Charging Temperature .....	19
LED Status Indicators .....	19
Replacing the Battery .....	20
Compatibility .....	21
Battery Comparison .....	21
Powering on the Device .....	22
Zebra Visibility Services .....	22
<b>Using the Device .....</b>	<b>24</b>
Home Screen .....	24
Setting Home Screen Rotation .....	25

## Table of Contents

Status Bar .....	25
Status Icons .....	26
Notification Icons .....	26
Managing Notifications .....	27
Quick Access Panel .....	28
Editing Icons on Quick Settings .....	29
Battery Management .....	29
Monitoring Battery Usage .....	29
Low Battery Notification .....	30
Battery Optimization .....	30
Suspend Mode .....	30
Transferring Files with a Host Computer via USB .....	30
Transferring Files .....	30
Transferring Photos .....	31
Disconnect from the Host Computer .....	31
<b>Settings.....</b>	<b>32</b>
Accessing Settings .....	32
Display Settings .....	32
Setting the Screen Brightness .....	32
Setting Night Light .....	32
Setting Screen Rotation .....	33
Setting Screen Timeout .....	33
Ambient Display .....	33
Setting Font Size .....	34
Setting Display Size .....	34
Setting Screen Saver .....	34
Configuring Screen Saver Settings .....	35
Setting the Date and Time .....	36
General Sound Setting .....	36
Sound Options .....	37
Remapping a Button .....	37
Keyboards .....	38
Keyboard Configuration .....	38
Enabling Keyboards .....	38
Switching Between Keyboards .....	38
Using the Android and Gboard Keyboards .....	38
Editing Text .....	38
Entering Numbers, Symbols, and Special Characters .....	38
Using the Enterprise Keyboard .....	39
Numeric Tab .....	39
Alpha Tab .....	39



## Table of Contents

Additional Character Tab .....	39
Scan Tab .....	40
Language Usage .....	40
Changing the Language Setting .....	40
Adding Words to the Dictionary .....	41
<b>Applications .....</b>	<b>42</b>
Accessing Apps .....	45
Switching Between Recent Apps .....	45
Battery Manager .....	45
Camera .....	48
Taking Photos .....	48
Recording Videos .....	49
Photo Settings .....	50
Front Camera .....	50
Video Settings .....	50
Front Camera .....	50
Cradle Firmware Updater .....	52
Sending the Firmware File Using Intents .....	53
Send an intent using ADB: .....	53
Send an intent using MDM .....	54
Send the file using the Recovery Method .....	54
Send an Airwatch intent .....	54
Send a SOTI intent .....	54
Cradle Utility .....	55
Controlling the Cradle .....	55
Setting the Cradle .....	56
Performing Cradle Diagnostics .....	56
Viewing Cradle Information .....	57
Smart Cradle Configuration .....	58
Support .....	58
Prerequisites/Assumptions .....	58
Error Prevention .....	58
Accessing CradleSmartConfig .....	59
Using CradleSmartConfig .....	59
Auditing .....	62
Quick Audit .....	62
Full Audit .....	62
Wall Map Examples .....	63
DataWedge Demonstration .....	64
Scanner Selection .....	64
Device Central .....	65

## Table of Contents

Scan and Pair Tab .....	65
Scan and Pair .....	65
Scan to Pair .....	66
Manually Pairing .....	66
Peripherals Tab .....	66
My Device Tab .....	66
Unpairing a Peripheral .....	66
Paging an RS6000 Ring Scanner .....	67
Diagnostic Tool .....	68
Settings .....	69
Battery Test Information .....	69
GPS Test Information .....	70
System Test Information .....	70
WLAN Test Information .....	70
WWAN Test Information .....	70
Bluetooth Test Information .....	70
Enterprise Browser .....	71
Enterprise Browser Application .....	71
RxLogger .....	72
RxLogger Configuration .....	72
Configuration File .....	72
Enabling Logging .....	72
Disabling Logging .....	72
Extracting Log Files .....	73
Backup .....	73
RxLogger Utility .....	73
Initiating the Main Chat Head .....	73
Removing the Main Chat Head .....	73
Viewing Logs .....	73
Removing a Sub Chat Head Icon .....	74
Backing Up In Overlay View .....	74
Sound Recorder .....	75
<b>Data Capture.....</b>	<b>76</b>
Introduction .....	76
Scanning Considerations .....	76
Scanning Bar Codes .....	76
Scanning Tips .....	78
Decode Screen Notification .....	78
Hands Free Scanning .....	78
Settings .....	78
Scanning Mode .....	79

## Table of Contents

Proximity Range .....	79
DataWedge .....	80
Enabling DataWedge .....	80
Disabling DataWedge .....	80
Decoders .....	80
<b>Wireless .....</b>	<b>83</b>
Wireless Local Area Networks .....	83
Accessing Settings .....	84
Connecting to a Wi-Fi Network .....	84
Removing a Wi-Fi Network .....	84
WLAN Configuration .....	85
Configuring a Secure Wi-Fi Network .....	85
Manually Adding a Wi-Fi Network .....	86
Configuring for a Proxy Server .....	86
Configuring the Device to Use a Static IP Address .....	87
Wi-Fi Preferences .....	88
Additional Wi-Fi Settings .....	88
Wi-Fi Direct .....	89
Wi-Fi Advanced Features .....	89
Bluetooth .....	90
Adaptive Frequency Hopping .....	90
Security .....	90
Bluetooth Profiles .....	91
Bluetooth Power States .....	91
Bluetooth Radio Power .....	92
Enabling Bluetooth .....	92
Disabling Bluetooth .....	92
Discovering Bluetooth Device(s) .....	92
Changing the Bluetooth Name .....	93
Connecting to a Bluetooth Device .....	93
Selecting Profiles on the Bluetooth Device .....	93
Unpairing a Bluetooth Device .....	93
Cast .....	94
<b>Accessories .....</b>	<b>95</b>
Accessories .....	95
Installation of the Single Slot Cradle .....	98
Charging Modes .....	98
Standard Charging Mode .....	98
Fast Charging Mode .....	98

## Table of Contents

Mounting the Single Slot Cradle on a Dispenser Wall .....	98
Wiring .....	101
Assembly .....	102
System Cabling .....	103
Installation of the Three Slot Cradle .....	105
Mounting Configurations .....	105
High Density Configuration .....	105
Super High Density Configuration .....	106
Desktop Configuration .....	107
Charging Modes .....	107
Standard Charging Mode .....	108
Fast Charging Mode .....	108
Mounting the Three Slot Cradle on a Dispenser Wall .....	109
Releasing the PS20 from the Charging Cradles .....	114
Software Release Using the Menu .....	115
Software Release Using the Cradle Utility .....	115
Manual Release Using a Release Key .....	115
Manual Release of the PS20 from the Single Slot Cradle .....	115
Manual Release of the PS20 from the Three Slot Cradle .....	116
USB Cable Battery Cover .....	117
Installing the USB Cable Battery Cover .....	117
Removing the USB Cable Battery Cover .....	118
Soft Holster .....	119
Using the Belt Clip .....	119
Using the Shoulder Strap .....	121
<b>Application Deployment.....</b>	<b>122</b>
Introduction .....	122
Security .....	122
Secure Certificates .....	122
Installing a Secure Certificate .....	122
Configuring Credential Storage Settings .....	123
Development Tools .....	123
Android Application Development .....	123
Development Workstation .....	123
Target Device .....	123
EMDK for Android .....	124
StageNow .....	124
MX Features .....	124
GMS Restricted .....	125
ADB USB Setup .....	125
Enabling USB Debugging .....	125

## Table of Contents

Application Installation .....	126
Installing Applications Using the USB Connection .....	126
Installing Applications Using the Android Debug Bridge .....	126
Uninstalling an Application .....	127
Performing a System Update .....	127
Downloading the System Update Package .....	127
Using ADB .....	127
Verify System Update Installation .....	128
Performing an Enterprise Reset .....	128
Downloading the Enterprise Reset Package .....	129
Using ADB .....	129
Performing a Factory Reset .....	130
Downloading the Factory Reset Package .....	130
Using ADB .....	130
Storage .....	131
Random Access Memory .....	131
On Device Storage .....	132
Internal Storage .....	132
Enterprise Folder .....	132
App Management .....	132
Viewing App Details .....	133
Managing Downloads .....	133
<b>Maintenance and Troubleshooting .....</b>	<b>134</b>
Introduction .....	134
Maintaining the Device .....	134
Battery Safety Guidelines .....	134
Long Term Storage .....	135
Cleaning Instructions .....	135
Approved Cleanser Active Ingredients .....	135
Harmful Ingredients .....	136
Device Cleaning Instructions .....	136
Special Cleaning Notes .....	136
Cleaning Materials Required .....	136
Cleaning Frequency .....	137
Cleaning the Device .....	137
Housing .....	137
Display .....	137
Camera and Exit Window .....	137
Cleaning Battery Connectors .....	137
Cleaning Cradle Connectors .....	137

## Table of Contents

Troubleshooting .....	138
Resetting the Device .....	138
Performing a Soft Reset .....	138
Performing a Hard Reset .....	138
Entering into Recovery Mode .....	139
PS20 .....	140
Cradles .....	142
<b>Specifications.....</b>	<b>143</b>
Introduction .....	143
Data Capture Supported Symbologies .....	143
Three Slot Cradle .....	143
Single Slot Cradle .....	144
PS20 Interface Connector Pin-Outs .....	144
Cable Specifications .....	145
Power Supply Cable, Y-type .....	145
Cradle Interconnection Cable .....	145

## Index

# About This Guide

## Configurations

This guide covers the following configurations:

Table 1

Configuration	Radios	Display	Memory	Data Capture Options	Operating System
PS20 Base	WLAN: 802.11 a/b/g/n/d/h/i/k/r/v/ac WPAN: Bluetooth v5.0	WVGA 4.0" color	4 GB RAM/16 GB Flash	SE2100	Android Open Source Project (AOSP)/ Google Mobile Services (GMS) 9.0
PS20 Plus	WLAN: 802.11 a/b/g/n/d/h/i/k/r/v/ac WPAN: Bluetooth v5.0	WVGA 4.0" color	4 GB RAM/16 GB Flash 4 GB RAM/32 GB Flash	SE4710 + Digimarc	Android Open Source Project (AOSP)/ Google Mobile Services (GMS) 9.0

## Notational Conventions

The following conventions are used in this document:

- **Bold** text is used to highlight the following:
  - Dialog box, window and screen names
  - Drop-down list and list box names
  - Check box and radio button names
  - Icons on a screen
  - Key names on a keypad
  - Button names on a screen.
- Bullets (•) indicate:
  - Action items
  - Lists of alternatives
  - Lists of required steps that are not necessarily sequential.
- Sequential lists (for example, those that describe step-by-step procedures) appear as numbered lists.

## Service Information

If you have a problem with your equipment, contact Customer Support for your region. Contact information is available at: [www.zebra.com/support](http://www.zebra.com/support).

When contacting support, please have the following information available:

- Serial number of the unit (found on manufacturing label)
- Model number or product name (found on manufacturing label)
- Software type and version number

Customer Support responds to calls by email or telephone within the time limits set forth in support agreements.

If the problem cannot be solved by Customer Support, you may need to return the equipment for servicing and will be given specific directions. We are not responsible for any damages incurred during shipment if the approved shipping container is not used. Shipping the units improperly can possibly void the warranty.

If the device was purchased from a business partner, contact that business partner for support.

## Software Versions

To determine the current software versions:

1. Go to **Settings**.
2. Touch **System**.
3. Touch **About phone**.
4. Scroll to view the following information:
  - **Model**
  - **Android version**
  - **Build number**.

To determine the device serial number, touch **About phone > Status**.

- **Serial number**



# Getting Started

## Unpacking

Carefully remove all protective material from the device and save the shipping container for later storage and shipping.

Verify that the box contains all the equipment listed below:

- PS20 (includes lithium-ion battery)
- Regulatory Guide

Inspect the equipment for damage. If you are missing any equipment or if you find any damaged equipment, contact Support immediately. See [Service Information on page 12](#) for contact information.

## Removing the Screen Protection Film

A screen protection film is applied to the PS20 screen to protect the screen during shipping. To remove the screen protector, carefully lift the thin film off the touch screen display.

## Features

Figure 1 Features - Front View

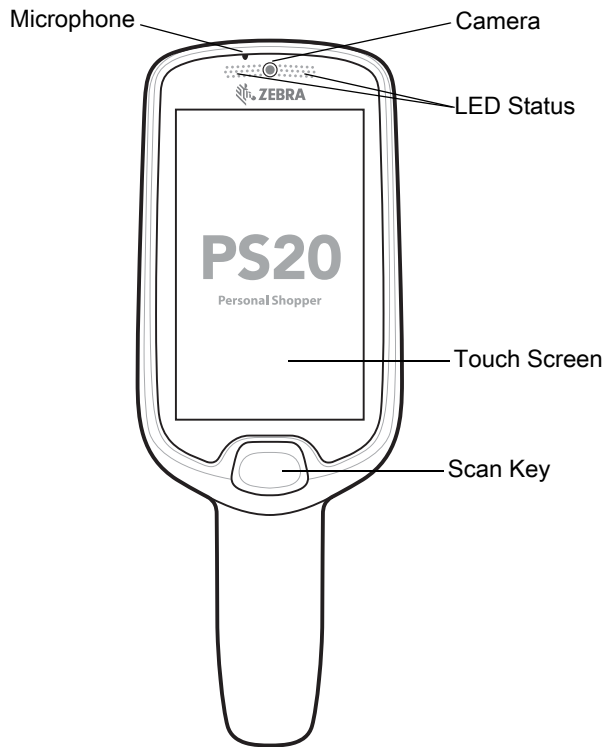

Table 2 Features- Front View

Item	Function
Microphone	Use for audio input and SmartLens locationing. Allows shoppers to speak to a store associate via push-to-talk or to a virtual assistant via speech-to-text.
Camera	With the front-facing camera, the device supports Visible Light Communications (VLC) indoor positioning/locationing applications. In addition, the camera is used for image/face recognition. Available on Plus configurations.
LED Status	Indicates the battery charge state while charging or the scan/decode status. Red: Barcode scan in progress (Scan key is pressed). Single Green Blink: Successful decode.
Touch Screen	Displays all information needed to operate the device.
Scan Key	Use for trigger input for scanner or as a Select/Enter key.

Figure 2 Features - Back and Side View

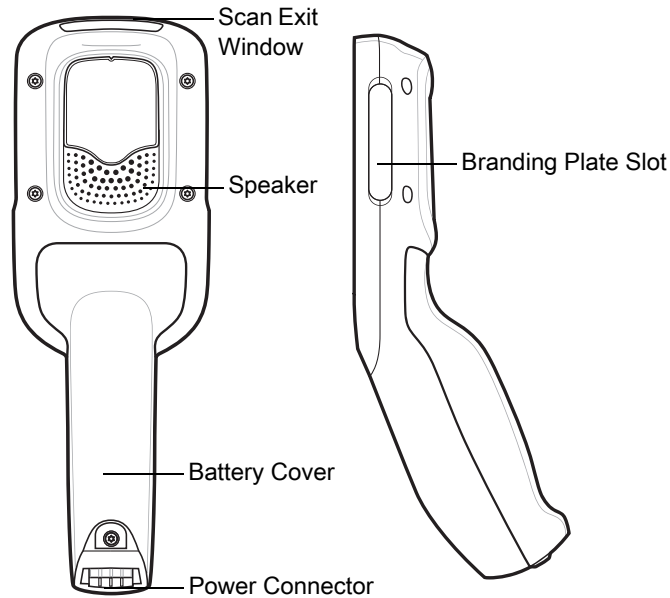

Table 3 Features- Back and Side View

Item	Function
Scan Exit Window	Provides data capture using the scanner.
Speaker	Provides audio output for video, music, notifications, and PTT.
Battery Cover	Encloses the battery and attaches to the device's handle.
Power/Cradle I/O Connector	Provides charging via cradle and cradle communication to lock/unlock the cradle slots. Use to perform a hard reset with the terminal reboot tool.
Branding Plate Slot	Provides space for custom logo.

## Status LED

The Status LED indicates imaging and charging status.

Figure 3 PS20 Status LED

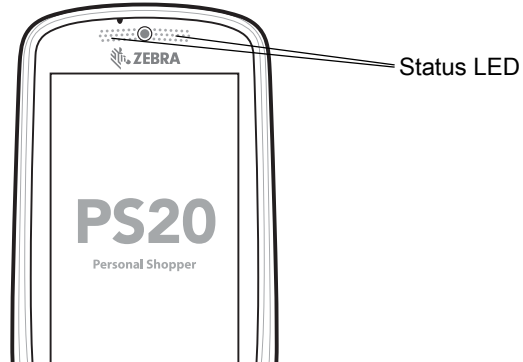

Table 4 Status LED Indications

LED State	Indication
<b>Imaging</b>	
Off	Normal operation or PS20 is turned off.
Red	Imaging in progress (Scan key is pressed).
Single Green Blink	Successful decode.
<b>Charging (PS20 docked in cradle)</b>	
Off	Power not applied to cradle. PS20 not inserted properly. Charging LED feature disabled.
Blinking Green	Charging.
Solid Green	Charging complete.
Blinking Red	Charging error, for example: Temperature is too low or too high. Charging has gone on too long without completion (typically eight hours).

## Scan Key

The Scan key operates the imager when a scanning application is active. When the PS20 is turned off, press the Scan key for three seconds to power on the PS20.

Figure 4 Scan Key

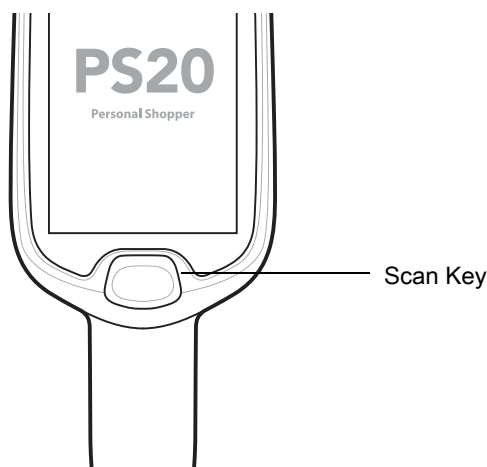

## Setting Up the Device

To start using the device for the first time:

- Charge the battery to at least 30% capacity.



**NOTE:** When the device is shipped from the factory, it is placed into Ship Mode, where the device enters its lowest possible power state. The device can exit Ship Mode by docking it in a powered cradle or in a powered USB cable. Fully charging the battery pack to 100% is recommended immediately after exiting ship mode to calibrate the state of charge.

## Charging the Battery

Use one of the following accessories to charge the PS20.

Table 5 Charging Cradles

Description	Part Number	Cables		
		DC Cable	Interconnect Cable	Extension Cable
Single Slot Cradle	CRD-MC18-1SLOT-01	CBL-DC-394A1-01 CBL-DC-393A1-02 CBL-DC-392A1-02	25-66431-01R 25-66430-01R	—
High Density (HD) Three Slot Cradle (Locking)	CRD-MC18-3SLCKH-01	CBL-DC-394A1-01 CBL-DC-393A1-02 CBL-DC-392A1-02	25-66431-01R 25-66430-01R	CBL-MC18-EXINT1-01
High Density (HD) Three Slot Cradle (Non-Locking)	CRD-MC18-SLOTH-01	CBL-DC-394A1-01 CBL-DC-393A1-02 CBL-DC-392A1-02	25-66431-01R 25-66430-01R	CBL-MC18-EXINT1-01
Super High Density (HD) Three Slot Cradle (Locking)	CRD-MC18-3SLCKS-01	CBL-DC-394A1-01 CBL-DC-393A1-02 CBL-DC-392A1-02	25-66431-01R 25-66430-01R	CBL-MC18-EXINT1-01



**NOTE:** Ensure that you follow the guidelines for battery safety described in the PS20 Product Reference Guide.

1. To charge the battery, connect the charging accessory to the appropriate power source.
2. Insert the PS20 into a cradle. The PS20 turns on and begins charging.

Figure 5 Single Slot Cradle

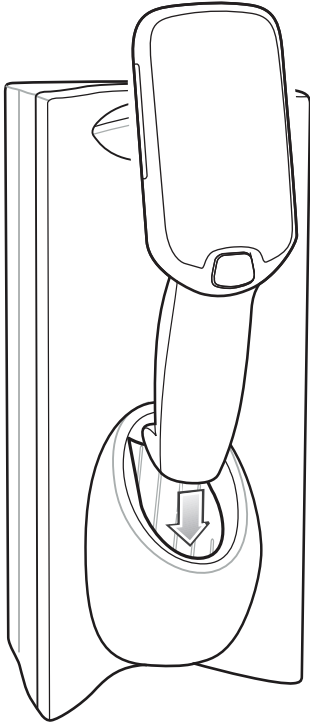
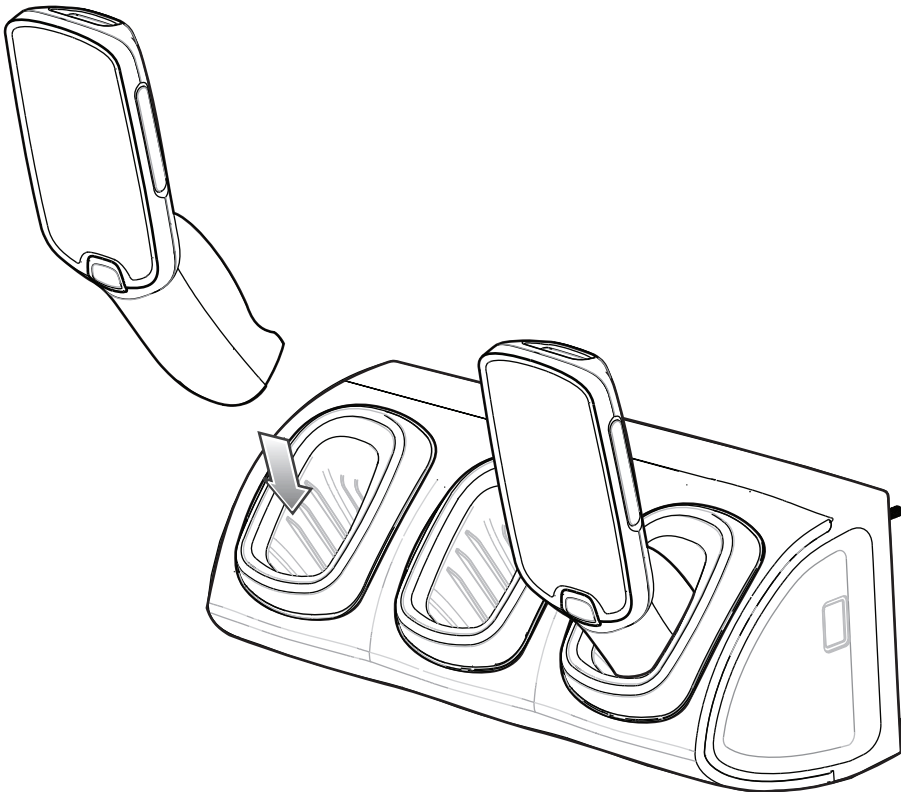

Figure 6 Three Slot Cradle



The battery charges 0 to 90% depending on the following conditions, measured at room temperature:

- When connected to a 1.0 cradle (normal charge mode), charge time is less than four hours.
- When connected to a 1.5 cradle (fast charge mode), charge time is less than three hours.



**NOTE:** To charge the battery in the device, it is recommended to use a charging cradle instead of the USB cable, since it is more time efficient.

## Charging Temperature

Charge batteries in temperatures from 0°C to 40°C (32°F to 104°F). The device or cradle always performs battery charging in a safe and intelligent manner. At higher temperatures (e.g. approximately +37°C (+98°F)) the device or cradle may for small periods of time alternately enable and disable battery charging to keep the battery at acceptable temperatures. The device and cradle indicates when charging is disabled due to abnormal temperatures via its LED.

## LED Status Indicators

By default, the charging LED indication is disabled.

To enable the charging LED indication:

1. Go to **Settings**.
2. Touch **Display**.
3. Touch **Charging LED**. The option switch turns green.
4. Touch .

Table 6 LED Status Indicators

LED State	Indication
<b>Imaging</b>	
Off	Normal operation or PS20 is turned off.
Red	Imaging in progress (Scan key is pressed).
Single Green Blink	Successful decode.
<b>Charging (PS20 docked in cradle)</b>	
Off	Power not applied to cradle. PS20 not inserted properly. Charging LED feature disabled.
Blinking Green	Charging.
Solid Green	Charging complete.
Blinking Red	Charging error, for example: Temperature is too low or too high. Charging has gone on too long without completion (typically eight hours).

## Replacing the Battery

To replace the battery:

1. Touch and hold the soft power button  until the menu appears.
2. Touch **Power Off**.
3. Touch **OK**.



**CAUTION:** The PS20 must be off before removing the battery. Failing to turn off the PS20 before removing the battery may damage the data stored on flash memory or corrupt the operating system files.

4. Loosen the captive screw that secures the battery cover, using a Phillips (PH00) screwdriver.
5. Lift the battery cover from the handle.
6. Inside the battery compartment, press down the plastic tab of the battery cable connector and slide it out of the shrouded male pin connector.
7. Remove the battery from the battery compartment.

Figure 7 Remove the Battery

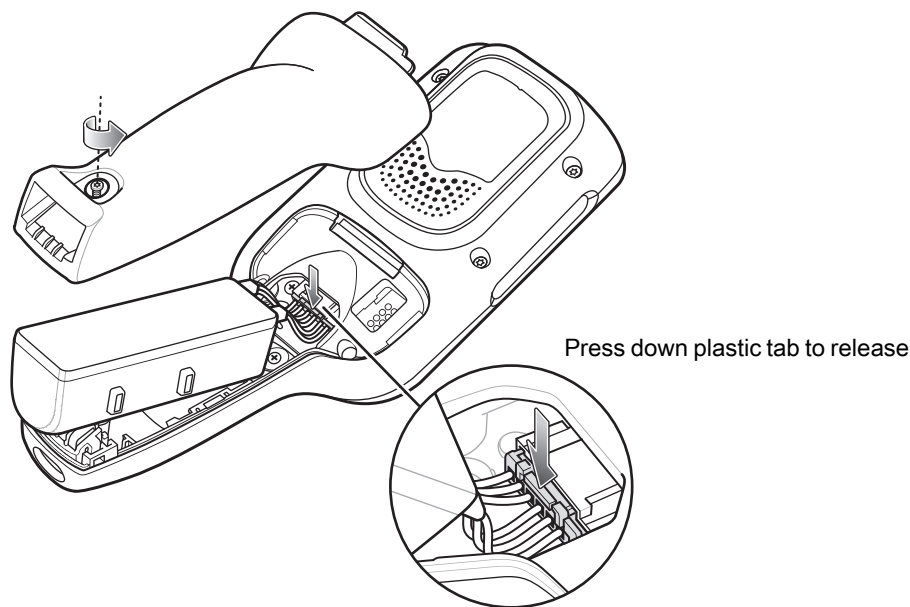

8. With the replacement battery, guide and press the battery cable connector into the shrouded male pin connector inside the battery compartment. The connector is designed to only fit one way.
9. Place the battery inside the battery compartment.
10. Place the battery cover onto the handle.
11. Secure the battery cover with the screw, using a Phillips (PH00) screwdriver.



Figure 8 Installing the Battery

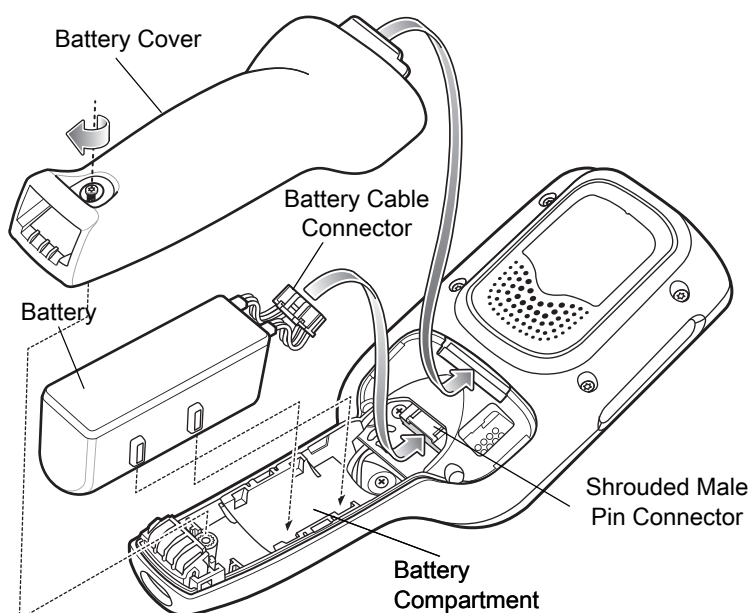

## Compatibility

The table below displays compatibility between the PS20 and MC18 devices and accessories.

Table 7 Compatibility

	PS20 Batteries	MC18 Batteries	MC18 Cradles
PS20	Yes	No	Yes
MC18	No	Yes	Yes

- PS20 PowerPrecision+ batteries are compatible with all PS20 devices and MC18 Single Slot and Three Slot cradles.
- PS20 PowerPrecision+ batteries are not compatible with MC18 devices.
- MC18 PowerPrecision+ batteries are not compatible with PS20 devices.

## Battery Comparison

The table below displays a comparison of the PS20 batteries with the MC18 batteries.

Table 8 Battery Comparison

Feature	MC18	PS20
Battery Type	PowerPrecision+	PowerPrecision+
Battery Capacity	2,275 mAh	3,500 mAh
Charging Mode	Standard and Fast	Standard and Fast

## Powering on the Device

The PS20 starts automatically as soon as power is applied; either with a charged battery installed or when inserted into the cradle.

If charged battery is installed and the PS20 is turned off, press the Scan key to turn on.

When the PS20 is powered on for the first time, it initializes its system. The splash screen appears for a short period of time.

Figure 9 Splash Screen



The splash screen is followed by the boot animation screen and then the **Home Screen**.

Figure 10 Home Screen

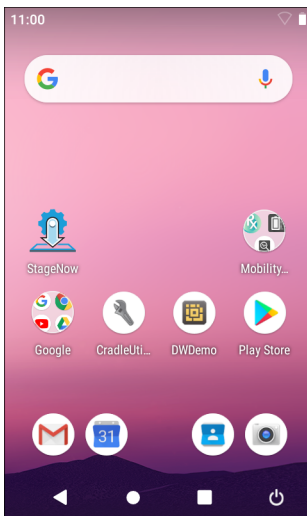

## Zebra Visibility Services

The device captures and provides device analytics to a system administrator. The first time the device boots (or after a Factory reset), the **Zebra Services** agreement screen displays.

Figure 11 Zebra Services

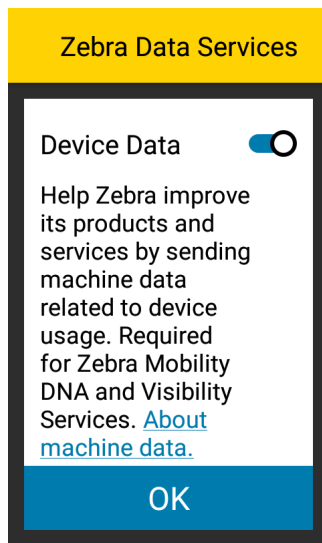

1. Touch the **Device Data** switch to disable the device from sending analytics data.
2. Touch **OK**.

# Using the Device

## Home Screen

Turn on the device to display the Home screen. Depending on the configuration, the Home screen may appear different. Contact your system administrator for more information.

After a suspend or screen time-out, the Home screen displays with the lock slider. Touch the screen and slide up to unlock. For screen locking information, see Un-Locking the Screen.

The Home screen provides additional screens for placement of widgets and shortcuts. Swipe the screen left or right to view the additional screens.



### NOTE:

By default, non-GMS devices do not have the same icons on the Home screen as GMS. Icons are shown below for example only.

Home screen icons can be configured by the user and may look different than shown.

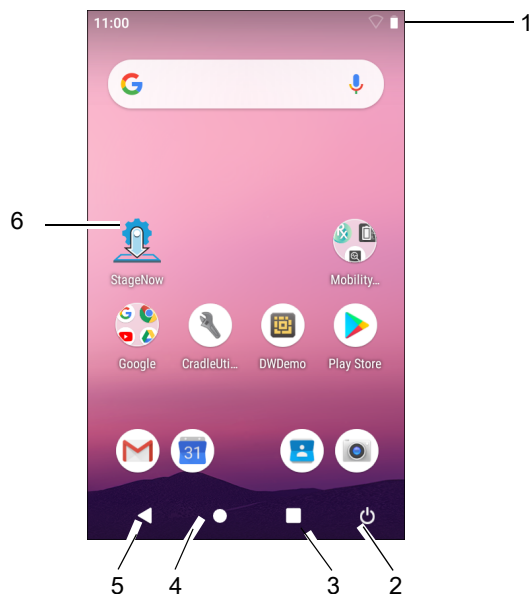

The Home screen consists of the following:

Table 9 Home Screen Items

Item	Description
1 — Status Bar	Displays the time, status icons (right side), and notification icons (left side). For more information see Notification Icons on page 26 and Managing Notifications on page 27.
2 — Power Icon	Places the PS20 in suspend mode when touched and opens menu when touched and held.
3 — Menu Icon	Displays running applications.
4 — Home Icon	Displays the Home screen.
5 — Back Icon	Displays the previous screen.
6 — Shortcut Icons	Opens applications installed on the PS20. See App Shortcuts and Widgets on page 54 for more information.

## Setting Home Screen Rotation

By default the **Home** screen rotation is disabled.

To enable **Home** screen rotation:

1. Touch and hold anywhere on the **Home** screen until the options appear.
2. Touch **Home settings**.
3. Touch the **Allow Home screen rotation** switch.
4. Touch .
5. Rotate the device.

## Status Bar

The Status bar displays the time, notification icons (left side), and status icons (right side).



**NOTE:** Some Status icons may not appear in the Status bar if there are too many icons to display.



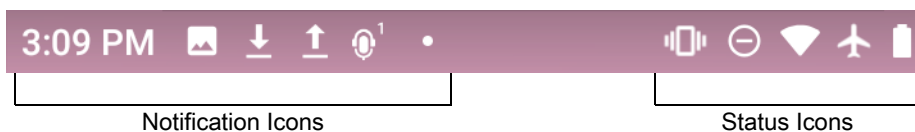











Figure 12 Notification and Status Icons



If there are more notifications than can fit in the Status bar, a dot displays indicating that more notifications exist. Swipe down from the Status bar to open the Notification panel and view all notifications and status.

## Status Icons

Table 10 Status Icons

Icon	Description
	Alarm is active.
	Main battery is fully charged.
	Main battery is partially drained.
	Main battery charge is low.
	Main battery charge is very low.
	Main battery is charging.
	All sounds, except media and alarms, are silenced and vibrate mode is active.
	Do Not Disturb mode active.
	Airplane Mode is active. All radios are turned off.
	Bluetooth is on.
	The device is connected to a Bluetooth device.
	Connected to a Wi-Fi network.
	Not connected to a Wi-Fi network or no Wi-Fi signal.
	Connected to an Ethernet network.
	Speakerphone enabled.

## Notification Icons

Table 11 Notification Icons

















Icon	Description
	Main battery is low.
	More notifications are available for viewing.
	Data is syncing.
	Indicates an upcoming event. Non-GMS devices only.
	Indicates an upcoming event. GMS devices only.
	Open Wi-Fi network is available.

Table 11 Notification Icons (Continued)

Icon	Description
	Song is playing.
	Problem with sign-in or sync has occurred.
	Device is uploading data.
	Device is downloading data when animated and download is complete when static.
	Device is connected to or disconnected from virtual private network (VPN).
	Preparing internal storage by checking it for errors.
	USB debugging is enabled on the device.
	Indicates that RxLogger app is running.
	Indicates the Bluetooth scanner is connected to the device.
	Indicates the RS6000 is connected to the device in HID mode.

## Managing Notifications

Notification icons report the arrival of new messages, calendar events, alarms, and ongoing events. When a notification occurs, an icon appears in the Status bar with a brief description. See Notification Icons for a list of possible notification icons and their description. Open the Notification panel to view a list of all the notifications.

To open the Notification panel, drag the Status bar down from the top of the screen.

Figure 13 Notification Panel

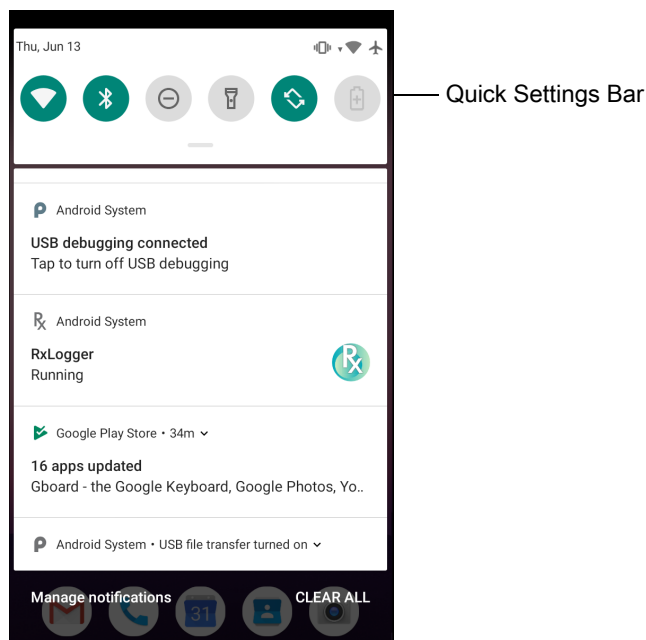

To respond to a notification, open the Notification panel and then touch a notification. The Notification panel closes and the corresponding app opens.

To manage recent or frequently used notifications, open the Notification panel and then touch **Manage notifications**. Touch the toggle switch next to an app to turn off all notifications, or touch an app for more notification options.

To clear all notifications, open the Notification panel and then touch **CLEAR ALL**. All event-based notifications are removed. Ongoing notifications remain in the list.

To close the Notification panel, swipe the Notification panel up.

### Quick Access Panel

Use the Quick Access panel to access frequently used settings (for example, Airplane mode).

Figure 14 Quick Settings Bar

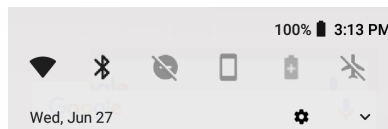

To see the full Quick Access panel:

- If the device is locked, swipe down once.
- If the device is unlocked, swipe down once with two fingers, or twice with one finger.
- If the Quick Settings bar is open, touch the Down arrow.
- If the Notification panel is open, swipe down from the Quick Settings bar.

Figure 15 Quick Access Panel

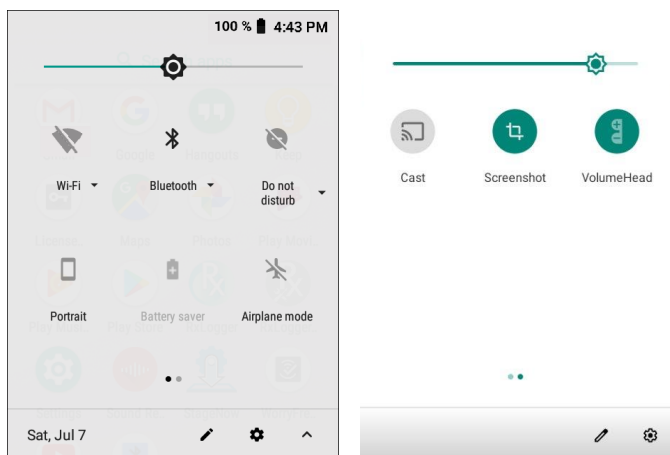

**NOTE:** Not all icons are pictured. Icons may vary.

To change a setting, touch the icon:

- Display brightness - Use the slider to decrease or increase the brightness of the screen.
- Wi-Fi network - Turn Wi-Fi on or off. To open Wi-Fi settings, touch the Wi-Fi network name.
- Bluetooth settings - Turn Bluetooth on or off. To open Bluetooth settings, touch **Bluetooth**.



- Battery power - Indicates percentage of battery power remaining. Touch to view battery usage.
- Do not disturb - Control how and when to receive notifications.
- Airplane mode - Turn Airplane mode on or off. When Airplane mode is on the device does not connect to Wi-Fi or Bluetooth.
- Auto-rotate - Lock the device's orientation in portrait or landscape mode or set to automatically rotate.
- Cast - Share phone content on Chromecast or a television with Google Cast built-in. Touch cast screen to display a list of devices, then touch a device to begin casting.
- Screenshot - Takes a snapshot of the current screen.
- VolumeHead - Creates a floating volume control +/- that can be used to change the volume of the speaker. It is normally used for Push to Talk use cases where the user needs to adjust the speaker volume.

### Editing Icons on Quick Settings

The first several setting tiles from the Quick Access panel become the Quick Settings bar. Open the Quick Access panel and touch  to edit, add, or remove settings tiles.

## Battery Management



**NOTE:** Prior to checking the battery charge level, remove the device from any AC power source (cradle or cable).

To check the charge status of the main battery, open **Settings** and touch **System > About phone > Battery Information**.

**Battery present status** indicates if the battery is present and **Battery level** lists the battery charge (as a percentage of fully charged). The battery percentage can also be viewed next to the battery icon in the quick access panel. Swipe down with two fingers from the status bar to open the quick access panel.

### Monitoring Battery Usage

The **Battery** screen provides battery charge details and power management options to extend battery life.

1. Go to **Settings**.
2. Touch **Battery**.

To display battery information and power management options for a specific app:

1. Go to **Settings**.
2. Touch **Apps & notifications**.
3. Touch an app.
4. Touch **Advanced > Battery**.

Different apps display different information. Some apps include buttons that open screens with settings to adjust power use. Use the **DISABLE** or **FORCE CLOSE** buttons to turn off apps that consume too much power.

## Low Battery Notification

When the battery charge level drops below 18%, the device displays a notice to connect the device to power. The user should charge the battery using one of the charging accessories.

When the battery charge drops below 10%, the device displays a notice to connect the device to power. The user must charge the battery using one of the charging accessories.

When the battery charge drops below 5%, the device turns off. The user must charge the battery using one of the charging accessories.

## Battery Optimization

Observe the following battery saving tips:

- Set the screen to turn off after a short period of non-use.
- Reduce screen brightness.
- Turn off all wireless radios when not in use.
- Turn off automatic syncing for Email, Calendar, Contacts, and other apps.
- Minimize use of apps that keep the device from suspending, for example, music and video apps.

## Suspend Mode

The device goes into suspend mode when you press the Scan button or after a period of inactivity (if the **Never** setting is changed to something else in **Settings > Display > Advanced > Sleep**).

To wake the device from Suspend mode, press the Scan button. The Lock screen displays. Swipe the screen up to unlock. If the Pattern screen unlock feature is enabled, the Pattern screen appears instead of the Lock screen. If the PIN or Password screen unlock feature is enabled, enter the PIN or password after unlocking the screen. See Un-Locking the Screen.



**NOTE:** If you enter the PIN, password, or pattern incorrectly five times, you must wait 30 seconds before trying again. If you forget the PIN, password, or pattern contact your system administrator.

## Transferring Files with a Host Computer via USB

Connect the device to a host computer using a USB cable to transfer files between the device and the host computer.

When connecting the device to a host computer, follow the host computer's instructions for connecting and disconnecting USB devices, to avoid damaging or corrupting files.

## Transferring Files



**NOTE:** Use Transfer files to copy files between the device (internal memory) and the host computer.

1. Connect a USB cable to the device.
2. Pull down the Notification panel and touch **USB charging this device**.  
By default, **Charge this device** is selected.

3. Touch **Transfer files**.



**NOTE:** After you change the setting to **Transfer files**, and then disconnect the USB cable, the setting reverts back to **Charge this device**. If the USB cable is reconnected, select **Transfer files** again.

4. On the host computer, open a file explorer application.
5. Locate the **device** as a portable device.
6. Open the **Internal storage** folder.
7. Copy files to and from the device or delete files as required.

## Transferring Photos

To transfer photos using Photo Transfer Protocol (PTP):



**NOTE:** Use PTP to copy photos from either the microSD card or internal memory to the host computer.

1. Connect USB cable to the device or place the device into a USB cradle. See [Accessories](#) for setup information.
2. Pull down the Notification panel and touch **Charging this device via USB**.
3. Touch **PTP**.
4. On the host computer, open a file explorer application.
5. Open the **Internal storage** folder.
6. Copy or delete photos as required.

## Disconnect from the Host Computer

To disconnect the device from the host computer:





**CAUTION:** Carefully follow the host computer's instructions to disconnect USB devices correctly to avoid losing information.

1. On the host computer, unmount the device.
2. Remove the USB cable from the device.

# Settings

## Accessing Settings

Access Settings in any of the following ways:

- Swipe down with two fingers from the top of the Home screen to open the Quick Access panel and touch .
- Double-swipe down from the top of the Home screen to open the Quick Access panel and touch .
- Swipe up from the bottom of the Home screen to open APPS and touch  **Settings**.

## Display Settings

Use Display settings to change the screen brightness, enable night light, change the background image, enable screen rotation, set sleep time, and change font size.

### Setting the Screen Brightness

To manually set the screen brightness using the touchscreen:

1. Swipe down with two fingers from the Status bar to open the Quick Access panel.
2. Slide the icon to adjust the screen brightness level.

Figure 16 Brightness Slider

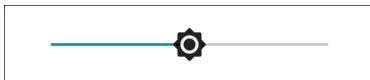

### Setting Night Light

The Night Light setting tints the screen amber, making the screen easier to look at in low light.

To enable night light:

1. Go to **Settings**.
2. Touch **Display**.
3. Touch **Night Light**.
4. Touch **Schedule**.

5. Select one of the schedule values:
  - None (default)
  - Turns on at custom time
  - Turns on from sunset to sunrise.
6. By default, **Night Light** is disabled. Touch **TURN ON NOW** to enable.
7. Adjust the tint using the **Intensity** slider.
8. Touch .

## Setting Screen Rotation

By default, screen rotation is enabled.

To disable screen rotation:

1. Go to **Settings**.
2. Touch **Display > Advanced**.
3. Touch **Auto-rotate screen**.



**NOTE:** To change the Home screen rotation, see Setting Home Screen Rotation.

4. Touch .

## Setting Screen Timeout

To set the screen sleep time:

1. Go to **Settings**.
2. Touch **Display > Advanced > Sleep**.
3. Select one of the sleep values.
  - **15 seconds**
  - **30 seconds**
  - **1 minute**
  - **2 minutes**
  - **5 minutes**
  - **10 minutes**
  - **30 minutes**
  - **Never** (default).
4. Touch .

## Ambient Display

The Ambient display setting wakes the screen when notifications are received.

To disable ambient display:

1. Go to **Settings**.
2. Touch **Display > Advanced**.
3. Touch **Ambient display**.
4. In the **When to show** section, enable or disable an option using the switch.
5. Touch .

### Setting Font Size

To set the size of the font in system apps:

1. Go to **Settings**.
2. Touch **Display > Advanced**.
3. Touch **Font size**.
4. Select one of the font size values.
  - Small
  - Default
  - Large
  - Largest.
5. Touch .

### Setting Display Size

By default, display size is set to default.

To change the display size:

1. Go to **Settings**.
2. Touch **Display > Advanced**.
3. Touch **Display size**.
4. Touch - and + to change the display size.
  - Small
  - Default
  - Large.
5. Touch .

### Setting Screen Saver

To change the screen saver:

1. Go to **Settings**.
2. Touch **Display > Advanced**.

3. Touch **Screen saver**.
4. Select the following:
  - **Current screen saver**
    - **PSSScreenSaver** (default)
    - **Clock**
    - **Colors**
    - **Photo Frame**
    - **Photo Table**
    - **Photos**
  - **When to start**
    - **While charging**
    - **While docked**
    - **While charging or docked** (default)
    - **Never**
5. Touch **START NOW** to see the screen saver.
6. Touch .



**NOTE:** To configure the screen saver settings, push `screensaverconfig.xml` to `/enterprise/device/settings/screensaver`. For more information, see [Ambient Display on page 35](#).

## Configuring Screen Saver Settings

To configure screen saver settings:

1. Prepare an xml file with the name `screensaverconfig.xml` and with the following fields:
  - **ENABLE** – set to true to enable the screen saver; set to false to disable the screen saver.
  - **EXCEPTION\_TIME\_START** – time in 24-hour format (only hours), after which the screen saver shall be disabled.
  - **EXCEPTION\_TIME\_STOP** – time in 24-hour format (only hours), after which the screen shall be enabled again.
  - **SCREEN\_TIMEOUT\_CHARGING** – The setting in **Display > Advanced > Sleep** while on the cradle (idle timeout). The value corresponds to the screen timeout delay in milliseconds, while on the cradle.
  - **SCREEN\_TIMEOUT\_DISCHARGING** – The setting in **Display > Advanced > Sleep** while out of the cradle (idle timeout). The value corresponds to the screen timeout delay in milliseconds, while out of the cradle.



**NOTE:** -1 for screen timeout indicates that the screen will never time out.

2. Push the configured `screensaverconfig.xml` file to the folder `/enterprise/device/settings/screensaver`.
3. If a different screen saver image is preferred rather than the default Zebra logo, create a 24-bit bmp image named `screensaver.bmp` and push it to the folder `/enterprise/device/settings/screensaver`.
4. Reboot the device.

### Example screensaverconfig.xml

```
<?xml version="1.0" encoding="utf-8"?>
<screensaver>
```

```

<ENABLE>true</ENABLE>
<EXCEPTION_TIME_START>20</EXCEPTION_TIME_START>
<EXCEPTION_TIME_STOP>6</EXCEPTION_TIME_STOP>
<SCREEN_TIMEOUT_CHARGING>15000</SCREEN_TIMEOUT_CHARGING>
<SCREEN_TIMEOUT_DISCHARGING>30000</SCREEN_TIMEOUT_DISCHARGING>
</screensaver>

```

The above example of the **screensaverconfig.xml**:

- Enables the screen saver feature.
- Defines no-screen saver time from 8 pm to 6 am.
- Sets the screen timeout to be 15 seconds on the cradle.
- Sets the screen timeout to be 30 seconds out of the cradle.

## Setting the Date and Time

You are only required to set the time zone or set the date and time if the wireless LAN does not support Network Time Protocol (NTP).

To set the date and time:

1. Go to **Settings**.
2. Touch **System > Date & time**.
3. Touch **Automatic date & time** to disable automatic date and time synchronization.
4. Touch **Set date**.
5. In the calendar, set today's date.
6. Touch **OK**.
7. Touch **Set time**.
8. Touch the green circle, drag to the current hour and then release.
9. Touch the green circle, drag to the current minute and then release.
10. Touch **AM** or **PM**.
11. Touch **OK**.
12. Touch **Use 24-hour format**.
13. Touch .

## General Sound Setting

Use the **Sound** settings to configure media and alarm volumes.



To access sound settings:

1. Go to **Settings**.
2. Touch **Sound**.



3. Touch an option to set sounds.

## Sound Options

- **Zebra volume controls**
  - **Ring volume** - Controls the ringtone volume.
  - **Media volume** - Controls the music, games, and media volume.
  - **Alarm volume** - Controls the alarm clock volume.
  - **Notifications volume** - Controls the notification volume.
  - **Scanner volume** - Controls the scanner volume.
  - **Volume presets**
    -  - Mutes the ring, notifications, and scanner so that the device does not make sounds or vibrate.
    -  - All sounds except media and alarms are silenced and vibrate mode is active.
    -  - Enables all sounds at the user defined levels.
- **Do Not Disturb preferences** - Mutes some or all sounds and vibrations.
  - **Priority only allows** - Use to set the priorities for the following:
    - **Reminders** - Switch on or off.
    - **Events** - Switch on or off.
    - **Alarms** - This is always enabled.
- **Advanced** - Touch to display advanced sound options.
  - **Default notification sound** - Touch to select a sound to play for all system notifications.
  - **Default alarm sound** - Touch to select a sound to play for alarms.
  - **Other sounds and vibrations**
    - **Screen locking sounds** - Play a sound when locking and unlocking the screen (default – enabled).
    - **Charging sounds** - Not applicable.
    - **Touch sounds** - Play a sound when making screen selections (default – enabled).
    - **Vibrate on tap** - Vibrate the device when making screen selections (default – disabled).
  - **Emergency alerts** - Touch to configure emergency broadcast settings and notifications.

## Remapping a Button

Buttons on the device can be programmed to perform different functions or as shortcuts to installed apps.



**NOTE:** It is not recommended to remap the scan button.

1. Go to **Settings**.
2. Touch **Key Programmer**. A list of programmable buttons displays.
3. Select the button to remap.
4. Touch the **BUTTON REMAPPING** tab or the **SHORTCUT** tab that lists the available functions and applications.
5. Touch a function or application shortcut to map to the button.



**NOTE:** If you select an application shortcut, the application icon appears next to the button on the Key Programmer screen.

6. Touch .

## Keyboards

Use the **Languages & input** settings to configure the on-screen keyboards. The device contains the following keyboard settings:

- Android Keyboard - Non-GMS devices only
- Gboard - GMS devices only
- Enterprise Keyboard.



**NOTE:** By default the Enterprise and Virtual Keyboards are disabled.

## Keyboard Configuration



### Enabling Keyboards

To enable keyboards:

1. Go to **Settings**.
2. Touch **System > Languages & input > Virtual keyboard > Manage keyboards**.
3. Touch a keyboard to enable.

### Switching Between Keyboards

To switch between keyboards, touch in a text box to display the current keyboard.

- On the Android or Gboard keyboards, touch and hold .
- On the Enterprise keyboard, touch .

## Using the Android and Gboard Keyboards

Use the Android or Gboard keyboards to enter text in a text field. To configure the keyboard settings, touch and hold  and then select **Android keyboard settings**.

### Editing Text

Edit entered text and use menu commands to cut, copy, and paste text within or across apps. Some apps do not support editing some or all of the text they display; others may offer their own way to select text.

### Entering Numbers, Symbols, and Special Characters

To enter numbers and symbols:

- Touch and hold one of the top-row keys until a menu appears then select a number or special character.
- Touch the Shift key once for a single capital letter. Touch the Shift key twice to lock in uppercase. Touch the Shift key a third time to unlock Capslock.
- Touch **?123** to switch to the numbers and symbols keyboard.

- Touch the **=\<** key on the numbers and symbols keyboard to view additional symbols.

To enter special characters, touch and hold a number or symbol key to open a menu of additional symbols. A larger version of the key displays briefly over the keyboard.

## Using the Enterprise Keyboard

The Enterprise Keyboard contains the following keyboards:

- Numeric
- Alpha
- Special characters
- Data capture.

### Numeric Tab

To access the numeric keyboard, touch the **123** tab. The keys displayed vary on the app being used. For example, an arrow displays in **Contacts**, however **Done** displays in **Email** account setup.

Figure 17 Numeric Keyboard

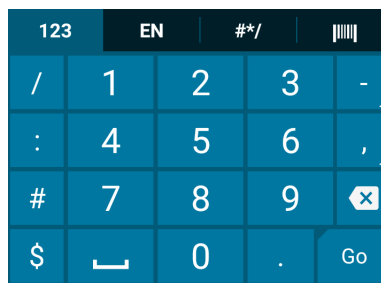
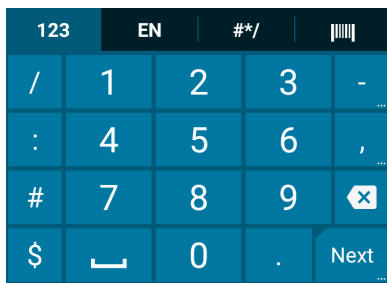

### Alpha Tab

To access the alpha keyboard, touch the **EN** tab.

Figure 18 Alpha Keyboard



### Additional Character Tab

To access additional characters, touch the **#\*/** tab.

Figure 19 Symbols Keyboard



Touch 😊 to enter emoji icons in a text message.

Figure 20 Emoji Keyboard

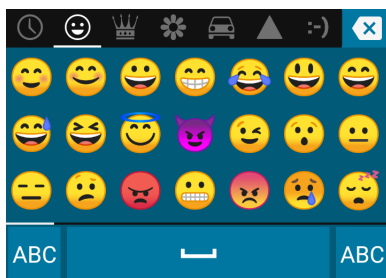

Touch **ABC** to return to the Symbols keyboard.

## Scan Tab

The Scan tab provides an easy data capture feature for scanning barcodes.

Figure 21 Scan Keyboard

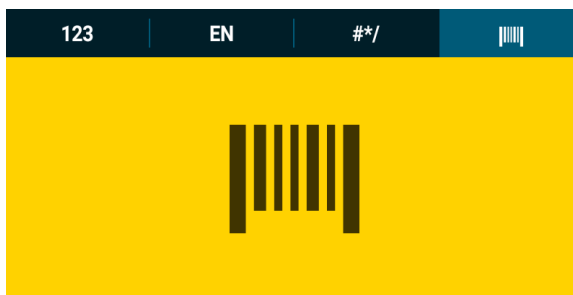

## Language Usage

Use the **Language & input** settings to change the device's language, including words added to the dictionary.

### Changing the Language Setting

1. Go to **Settings**.
2. Touch **System > Languages & input**.
3. Touch **Languages**. A list of available languages displays.

4. If the desired language is not listed, touch **Add a language** and select a language from the list.
5. Touch and hold  to the right of the desired language, then drag it to the top of the list.
6. The operating system text changes to the selected language.









### Adding Words to the Dictionary

1. Go to **Settings**.
2. Touch **System > Languages & input > Advanced > Personal dictionary**.
3. If prompted, select the language where this word or phrase is stored.
4. Touch **+** to add a new word or phrase to the dictionary.
5. Enter the word or phrase.
6. In the **Shortcut** text box, enter a shortcut for the word or phrase.
7. Touch .















# Applications

The **APPS** screen displays icons for all installed apps. The table below lists the apps installed on the device. See Application Deployment for information on installing and uninstalling apps. For more information on standard Android apps, go to [www.support.google.com](http://www.support.google.com).

**Table 12** Apps

Icon	Description
	<b>Battery Manager</b> - Displays battery information, including charge level, status, health and wear level.
	<b>Bluetooth Pairing Utility</b> – Use to pair peripherals with the device by scanning a barcode.
	<b>Calculator</b> - Provides the basic and scientific arithmetic functions.
	<b>Calendar</b> - Use to manage events and appointments. GMS/GMS-Restricted only.
	<b>Calendar</b> - Use to manage events and appointments. AOSP only.
	<b>Camera</b> - Take photos or record videos. For more information see Camera. Available on Plus configurations.
	<b>Chrome</b> - Use to access the Internet or intranet. GMS only
	<b>Chromium</b> - Use to access the Internet or intranet. AOSP only.
	<b>Clock</b> - Use to schedule alarms for appointments or as a wake-up.

**Table 12** Apps (Continued)

Icon	Description
	<b>Contacts</b> - Use to manage contact information. See Contacts for more information.
	<b>Cradle Firmware Updater</b> - Use to update cradle firmware.
	<b>Cradle Utility</b> - Use to control cradle functionality.
	<b>DataWedge</b> - Enables data capture using the imager.
	<b>Device Central</b> - Use to display detailed information about the device and connected peripherals. See Device Central for more information.
	<b>Diagnostic Tool</b> - Use to diagnose the device.
	<b>Drive</b> - Upload photos, videos, documents, and other files to personal storage site. GMS only.
	<b>DWDemo</b> - Provides a way to demonstrate the data capture features using the imager. See DataWedge Demonstration for more information.
	<b>Email</b> - Use to send and receive email. AOSP only.
	<b>Enterprise Browser</b> - Industrial browser that provides everything needed to quickly build device apps for barcode scanning, signature capture, payment processing, printing and most other enterprise applications. For more information, refer to <a href="http://techdocs.zebra.com/enterprise-browser/">techdocs.zebra.com/enterprise-browser/</a> .
	<b>Files</b> - Organize and manage files on the device. See Files for more information.
	<b>Gallery</b> - Use to view photos stored on the internal storage. For more information, see Gallery for more information. AOSP only.
	<b>Gmail</b> - Use to send and receive email using a Google™ email account. GMS only
	<b>Google</b> - Launches Google™ search app. GMS only

**Table 12** Apps (Continued)

















Icon	Description
	<b>Hangouts</b> - Use to communicate with friends using text messages and photos. GMS only
	<b>Keep</b> - Use to create, edit, and share notes. GMS only.
	<b>License Manager</b> - Use to manage software licenses on the device.
	<b>Maps</b> - Use to see your location on a map (with public transit, traffic, or satellite overlays). Search for any business or place of interest. Provides turn-by-turn navigation with voice guidance, traffic-avoidance, and alternate routes, for drivers, cyclists, walkers, and users of public transportation. GMS only.
	<b>Music</b> - Play music stored on the internal storage. AOSP only.
	<b>Photos</b> - Use to sync photos with Google account. For more information, see Photo Settings. GMS only.
	<b>Play Movies &amp; TV</b> - View movies and video on your device. GMS/GMS-Restricted only.
	<b>Play Music</b> - Use to listen to music. GMS/GMS-Restricted only.
	<b>Play Store</b> - Download music, movies, books, and Android apps and games from the Google Play™ Store. GMS only.
	<b>RxLogger</b> - Use to diagnose device and app issues.
	<b>Search</b> - Use to search the Web. Requires an Internet connection. AOSP only.
	<b>Settings</b> - Use to configure the device.
	<b>Sound Recorder</b> - Use to record audio. Available on Plus configurations.
	<b>StageNow</b> - Allows the device to stage a device for initial use by initiating the deployment of settings, firmware, and software.



Table 12 Apps (Continued)

Icon	Description
	<b>Worry Free Wifi Analyzer</b> - A diagnostic intelligent app. Use to diagnose surrounding area and display network stats, such as coverage hole detection, or AP in vicinity. Refer to the Worry Free Wi-Fi Analyzer Administrator Guide for Android.
	<b>YouTube</b> - Use to view videos on the YouTube™ web site. GMS only.
	<b>Zebra Bluetooth</b> - Use to configure Bluetooth logging.



## Accessing Apps

All apps installed on the device are accessed using the **APPS** window.

1. On the Home screen, swipe up from the bottom of the screen.
2. Slide the **APPS** window up or down to view more app icons.
3. Touch an icon to open the app.

## Switching Between Recent Apps

To switch between recent apps:

1. Touch . A window appears on the screen with icons of recently used apps.
2. Slide the apps displayed up and down to view all recently used apps.
3. Swipe left or right to remove app from the list and force close the app.
4. Touch an icon to open an app or touch  to return to the current screen.

## Battery Manager

The **Battery Manager** provides detailed information about the battery.

To open Battery Manager, swipe up from the bottom of the Home screen and touch .

Table 13 Battery Icon Description





Battery Icon	Description
	Battery charge level.

Table 13 Battery Icon Description

Battery Icon	Description
	Battery charging.
	Battery charge level is below 20%.

- **Battery level** - The current battery charge level as a percentage. Displays -% when level is unknown.
- **Time until full** - The amount of time until the battery is fully charged.
- **Time since charging** - The amount of time since the device began charging.
- **Time until empty** - The amount of time until the battery is empty.
- **Battery status**
  - **Not charging** - The device is not connected to AC power.
  - **Charging over AC** - The device is connected to AC power and charging.
  - **Charging over USB** - The device is connected to a host computer with a USB cable and charging.
  - **Discharging** - That the battery is discharging.
  - **Full** - That the battery is fully charged.
  - **Unknown** - The battery status is unknown.
- **Battery health** - The health of the battery. If a critical error occurs,  appears. Touch to view the error description.
  - **Decommission** - The battery is past its useful life and should be replaced. See system administrator.
  - **Good** - The battery is good.
  - **Charge error** - An error occurred while charging. See system administrator.
  - **Over Current** - An over-current condition occurred. See system administrator.
  - **Dead** - The battery has no charge. Replace the battery.
  - **Over Voltage** - An over-voltage condition occurred. See system administrator.
  - **Below Temperature** - The battery temperature is below the operating temperature. See system administrator.
  - **Failure Detected** - A failure has been detected in the battery. See system administrator.
  - **Unknown** - See system administrator.
- **Wear level** - The health of the battery in graphical form. When the wear level exceeds 80%, the bar color changes to red.

- **Advanced info** - Touch to view additional battery information.
  - **Battery present status** - Indicates that the battery is present.
  - **Battery level** - The battery charge level as a percentage of scale.
  - **Battery scale** - The battery scale level used to determine battery level (100).
  - **Battery voltage** - The current battery voltage in millivolts.
  - **Battery temperature** - The current battery temperature in degrees Centigrade.
  - **Battery technology** - The type of battery.
  - **Battery current** - The average current into or out of the battery over the last second in mAh.
  - **Battery manufacture date** - The date of manufacture.
  - **Battery serial number** - The battery serial number. The number matches the serial number printed on the battery label.
  - **Battery part number** - The battery part number.
  - **Battery rated capacity** - Lists the rated capacity of the backup battery in mAh.
  - **Battery decommission status** - Indicates if the battery is past its life span.
    - **Battery Good** - The battery is in good health.
    - **Decommissioned Battery** - The battery is past its useful life and should be replaced.
  - **Base cumulative charge** - Cumulative charge using Zebra charging equipment only.
  - **App version** - The application version number.

## Camera



**NOTE:** This app is available on the Plus configuration.

This section provides information for taking photos and recording videos using the integrated digital cameras.



The device saves photos and videos on the internal storage.

## Taking Photos





**NOTE:** See Photo Settings for camera setting descriptions.

1. Swipe up from the bottom of the Home screen and touch **Camera**.

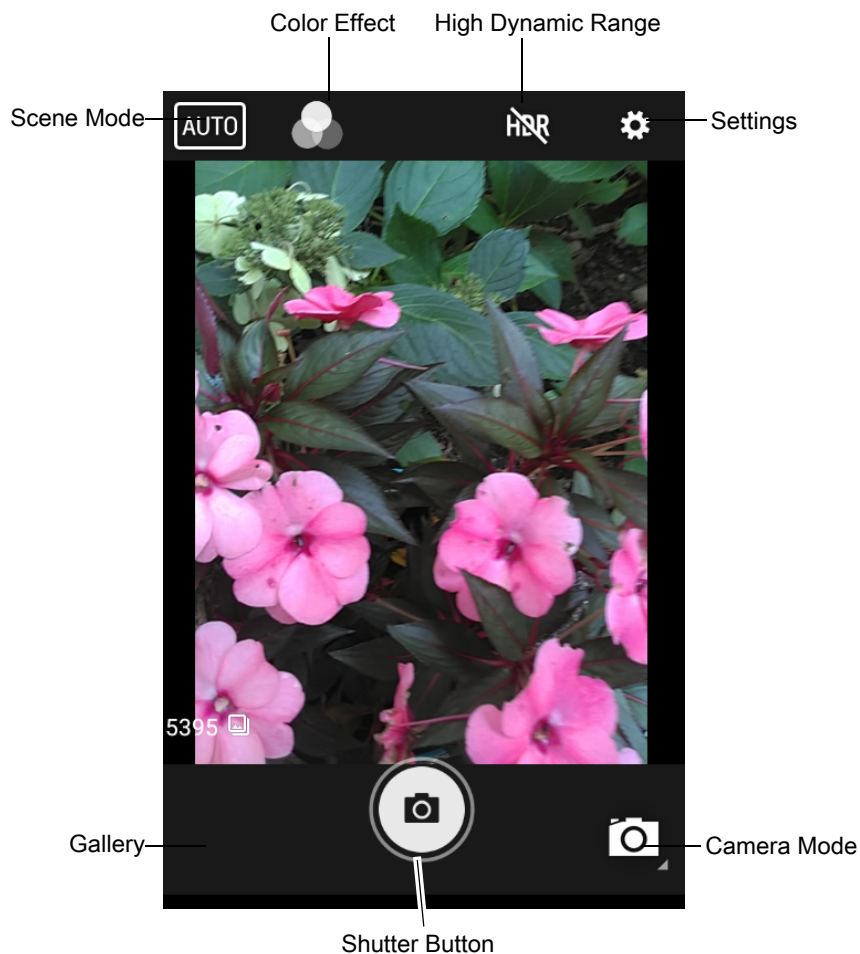
Figure 22 Camera Mode



2. If necessary, touch the Camera Mode icon and touch .
3. Frame the subject on the screen.

4. To zoom in or out, press two fingers on the display and pinch or expand fingers. The zoom controls appear on the screen.
5. Touch an area on the screen to focus. The focus circle appears. The two bars turn green when in focus.
6. Touch .
- The camera takes a photo and a shutter sound plays.
- The photo momentarily displays as a thumbnail in the lower left corner.

## Recording Videos



1. Swipe up from the bottom of the Home screen and touch **Camera**.
2. Touch the camera mode menu and touch .

Figure 23 Video Mode



3. Point the camera and frame the scene.
4. To zoom in or out, press two fingers on the display and pinch or expand fingers. The zoom controls appear on the screen.
5. Touch  to start recording.
- The video time remaining appears in the top left of the screen.

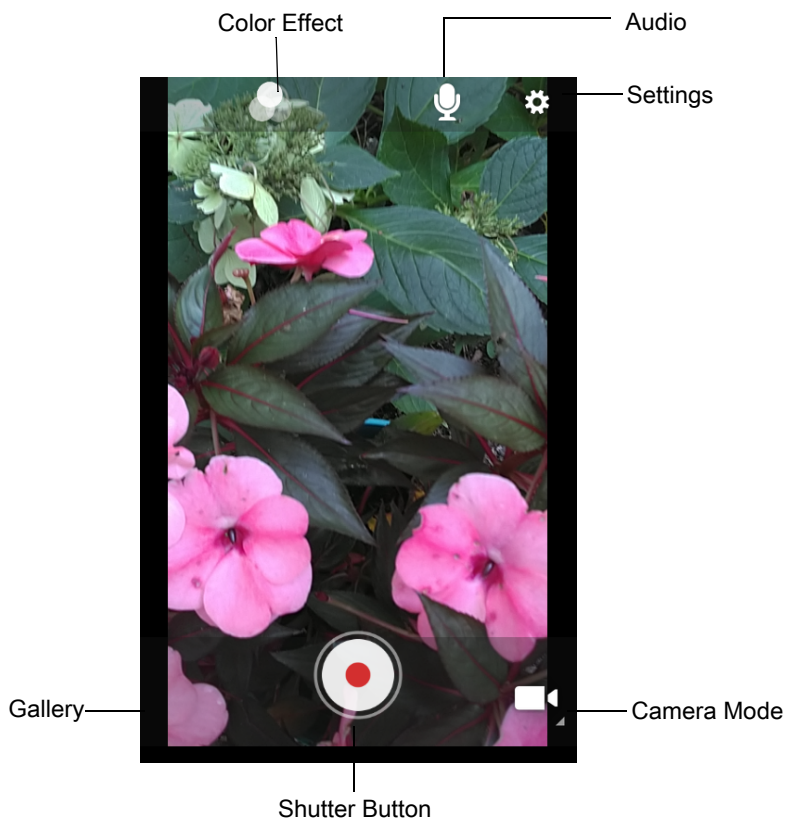



6. Touch  to the end recording.

The video momentarily displays as a thumbnail in the lower left corner.

## Photo Settings

In Photo mode, photo settings appear on screen. Touch  to display the photo settings options.

### Front Camera





- **Selfie Flash** - Turns screen white to help produce a little extra light in dimmer settings. Options: **Off** (default), or **On**.
- **Picture size** - Set the size (in pixels) of the photo to: **5M pixels** (default), **3M pixels**, **HD1080**, **2M pixels**, **HD720**, **1M pixels**, **WVGA**, **VGA**, or **QVGA**.
- **Picture quality** - Set picture quality setting to: **Low**, **Standard** (default) or **High**.
- **Countdown timer** - Set to: **Off** (default), **2 seconds**, **5 seconds** or **10 seconds**.
- **Storage** – Set location to store the photo to: **Phone**.
- **Face Detection** - Select to turn face detection **Off** (default) or **On**.
- **ISO** - Set how sensitive the camera is to light. Options: **Auto** (default), **ISO Auto (HJR)**, **ISO100**, **ISO200**, **ISO400**, **ISO800** or **ISO1600**.
- **Exposure** - Touch to adjust the exposure settings. Options: **+2**, **+1**, **0** (default), **-1** or **-2**.
- **White balance** - Select how the camera adjusts colors in different kinds of light, to achieve the most natural-looking colors:
  -  **Incandescent** - Adjust the white balance for incandescent lighting.
  -  **Fluorescent** - Adjust the white balance for florescent lighting.
  -  **Auto** - Adjust the white balance automatically (default).
  -  **Daylight** - Adjust the white balance for daylight.
  -  **Cloudy** - Adjust the white balance for a cloudy environment.
- **Redeye reduction** - Helps eliminate redeye effect. Options: **Disabled** (default), or **Enable**.
- **ZSL** - Set the camera to immediately take a picture when the button is pressed (default – enabled)
- **Selfie Mirror** - Options: **Disable** (default), or **Enable**.
- **Shutter Sound** - Options: **Enable** (default), or **Disable**.
- **Anti Banding** - Allows the camera to avoid problems caused by artificial light sources that are not constant. These sources cycle (flicker) fast enough to go unnoticed to the human eye, appearing continuous. The camera's eye (its sensor) can still see this flicker. Options: **Auto** (default), **60 Hz**, **50 Hz**, or **Off**.

## Video Settings

In Video mode, video settings appear on screen. Touch  to display the video settings options.

### Front Camera

- **Video quality** - Set video quality to: **HD 1080p** (default), **HD 720p**, **SD 480p**, **VGA**, **CIF**, or **QVGA**.
- **Video duration** - Set to: **30 seconds (MMS)** or **30 minutes** (default).
- **Storage** – Set the location to store the photo to: **Phone**.

- **White balance** - Select how the camera adjusts colors in different kinds of light, to achieve the most natural-looking colors.
  -  **Incandescent** - Adjust the white balance for incandescent lighting.
  -  **Fluorescent** - Adjust the white balance for florescent lighting.
  -  **Auto** - Adjust the white balance automatically (default).
  -  **Daylight** - Adjust the white balance for daylight.
  -  **Cloudy** - Adjust the white balance for a cloudy environment.
- **Image Stabilization** - Set to reduce blurry videos due to device movement. Options: **On** or **Off** (default).

## Cradle Firmware Updater

The **Cradle Firmware Updater** app (**CradleFWUpdater**) allows the manual updating of cradle firmware using the PS20.

To update cradle firmware:

1. Go to the Zebra Support & Downloads web site, [zebra.com/support](http://zebra.com/support) or contact a Zebra Support Representative.
2. Download the **MC18CradleFWvx\_x** firmware file to a host computer.
3. Using Android Debug Bridge (adb) or the sideload process, copy the firmware file to the PS20.
4. Swipe up from the bottom of the Home screen and touch  **CradleFWUpdater**.  
The **CradleFWUpdater** screen displays.

Figure 24 CradleFWUpdater Screen



5. Dock the device in the cradle.
6. Select **FW File location**.  
The **Files** app opens.
7. Select the appropriate HEX firmware file and select OK.  
The path of the selected file displays in the **Input FW File** text box.
8. Verify the filename and extension.
9. Select **Program Firmware**. A warning dialog displays **Please don't remove device from cradle until FW Update complete. Continue?**
10. Select **OK** to initiate the firmware update process.

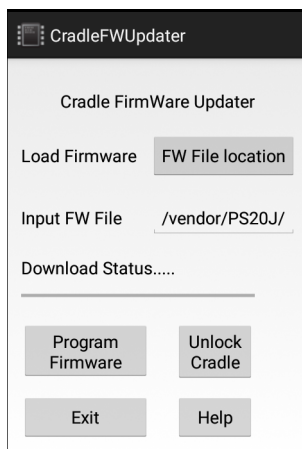

**NOTE:** During the firmware initiation process, the application resets the cradle. If the following error dialog displays: **Please manually reset the cradle and then press OK**, the user is required to manually reset the cradle.

To manually reset the cradle:

- a. Disconnect power from the power supply unit of the cradle.
- b. Reconnect power to the power supply unit of the cradle.



- c. Select **OK** within 10 seconds after power on and before the LEDs on the cradle start glowing, to remove the error message and continue. Failing to select **OK** before the LEDs starts glowing will re-display the error message. If the user fails continuously 2 times, the firmware update process stops.
- d. If the app is successful, it will start the downloading process.

11. After resetting the cradle, the app starts the firmware download process.

Figure 25 Cradle Firmware Updater - Firmware Download Process Screen

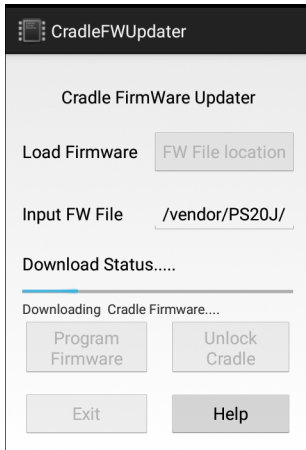

**CAUTION:** Do not attempt to disconnect power from the cradle or remove the device from the cradle during cradle firmware update. Removing the device from the cradle while firmware update is ongoing would result in an incomplete firmware update, leaving the cradle with partial firmware. To recover from the situation of partially downloaded firmware, open the **Cradle Firmware Updater** app and perform a manual reset of the cradle power when alerted.

- 12. When **Download Complete** displays on the screen, the firmware update process is completed successfully. Select **Unlock Cradle** to unlock and remove the device from the cradle. Select **Help** for app information and instructions for using the app.

Figure 26 Cradle Firmware Updater - Download Complete Screen

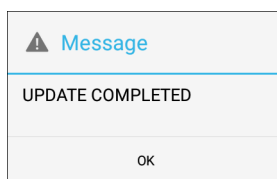

## Sending the Firmware File Using Intents

### Send an intent using ADB:

To send an intent using ADB:

1. Push the file to any location, preferably an sdcard or the following: enterprise/device/settings/cradleupdate.

2. Send the following intent:

```
adb shell am broadcast -a com.symbol.intent.cradlefw.update --es cradleFwPath '<filename-alongwithpath>'
```

Example:

```
adb shell am broadcast -a com.symbol.intent.cradlefw.update --es cradleFwPath '/enterprise/device/settings/cradleupdate/MC18CradleFWv5_1.txt'
```

### Send an intent using MDM

To send an intent using MDM:

1. Push the file to the internal storage memory.
2. Send the following command to change the permission of the file:

```
chmod 644 <file-alongwithpath>
```

3. Send the following intent:

```
adb shell am broadcast -a com.symbol.intent.cradlefw.update --es cradleFwPath '<filename-alongwithpath>'
```

Example:

```
adb shell am broadcast -a com.symbol.intent.cradlefw.update --es cradleFwPath '/enterprise/device/settings/cradleupdate/MC18CradleFWv5_1.txt'
_chmod 644 /enterprise/device/settings/cradleupdate/MC18CradleFWv5_2.txt
```

### Send the file using the Recovery Method

To send the file using the Recovery Method:

1. Put the device in Recovery Mode.
2. Select Update via adb > FullPackageUpdate.
3. Enter the following at a command prompt:  
adb sideload <packagename>.
4. Reboot the device.

### Send an Airwatch intent

To send an Airwatch intent:

1. Send the following intent:

```
broadcast=true,mode=implicit,action=com.symbol.intent.cradlefw.update,extraString=cradleFwPath=/enterprise/device/settings/cradleupdate/MC18CradleFWv5_2.txt
```

### Send a SOTI intent

To send a SOTI intent:

1. Send the following intent:

```
sendintent -b
"intent:#Intent;action=com.symbol.intent.cradlefw.update;S.cradleFwPath=/enterprise/device/settings/cradleupdate/MC18CradleFWv5_1.txt;end;"
```

## Cradle Utility

Use the **Cradle Utility** to:

- Perform cradle operations (for example, unlock cradle or set LED)
- Configure cradle information (for example, Row ID or Column ID)
- Read the cradle manufacturing information
- Read the cradle diagnostics information.

To use the Cradle Utility:

1. Dock the PS20 inside the cradle.
2. Swipe up from the bottom of the Home screen and touch .



**NOTE:** The cradle ID and location information and charge settings are retained across firmware upgrades.

## Controlling the Cradle

1. Tap the **CRADLE UNLOCK** tab to set the cradle unlock information.

Figure 27 Cradle Utility - Cradle Unlock Tab

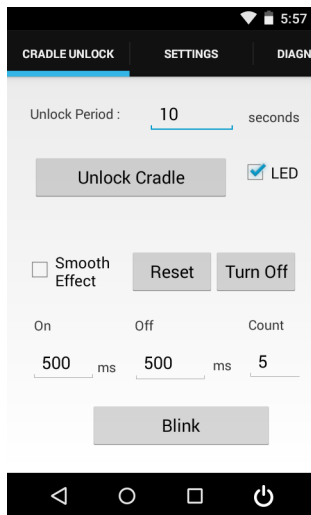

- **Unlock Period:** The duration in seconds for which the PS20 remains in unlocked state (if not removed from the cradle). For example; if unlock period is set to 15 and unlock signal is received, the PS20 will unlock and lock back after 15 seconds (if its not removed by user).
- **Unlock Cradle:** Press **Unlock Cradle** to manually unlock the PS20 from the cradle.
- **LED:** Check the LED box to enable the cradle LED indication.
- **Smooth Effect:** Check the Smooth Effect box to enable smooth blinking of the LEDs.
- LED Setting > **On:** The duration (in ms) that the cradle LED remains turned on or blinks during unlock.
- LED Setting > **Off:** The duration (in ms) that the cradle LED remains turned off or blinks during unlock.
- LED Setting > **Count:** The number of times the cradle LED blinks when user presses the blink button.
- **Blink:** Tap to test the cradle LED operation.

## Setting the Cradle

The **Cradle Utility** allows you to manually enter cradle settings. To automatically enter cradle settings, use the optional Smart Cradle Configuration app (**CradleSmartConfig**).

**Setting the cradle charging rate:** Depending on the cradle installation configuration, the store technician can configure each individual cradle slot to enable/disable fast charge. Each cradle can be configured to charge its docked terminal at 1A (normal charging mode - default setting) or 1.5A (fast charging mode).



**NOTE:** The cradle charging rate is retained across firmware upgrades.

1. Tap the **Settings** tab to set the cradle information.

Figure 28 Cradle Utility - Setting Tab

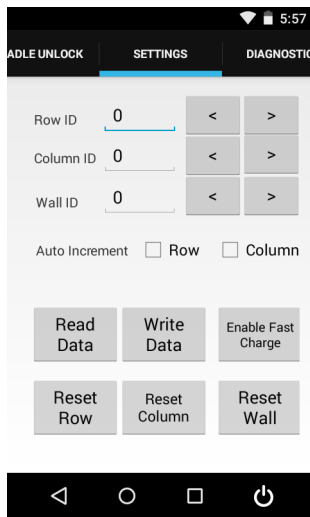

- **Row ID:** The cradle row number in the dispenser wall.
- **Column ID:** The cradle column number in the dispenser wall.
- **Wall ID:** The number of dispenser wall where the cradle is positioned.
- **Read Data:** Retrieve setting data from the cradle memory and display on the screen.
- **Write Data:** Tap this button to program the row/col/wall information onto the cradle. Note that each slot on the Three Slot Cradle needs to be programmed separately.
- **Enable Fast Charge:** Enable the cradle to charge the PS20 at a current of 1.5A (default setting is 1A)
- **Reset Row:** Tap to update the **Row ID** in the text field to “0” on the application.
- **Reset Column:** Tap to update the **Column ID** in the text field to “0” on the application.
- **Reset Wall:** Tap to update the **Wall ID** in the text field to “0” on the application.

## Performing Cradle Diagnostics

1. Touch **Diagnostic** tab to perform the cradle diagnostics:

Figure 29 Cradle Utility - Diagnostic Tab

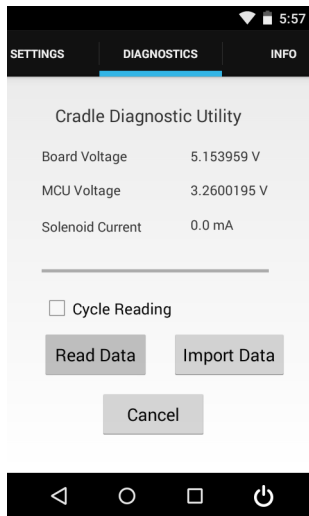

- **Cycle Reading:** Check the **Cycle Reading** box to perform continuous diagnostics and display the cradle status information. During diagnostics, a progress bar is shown of the screen.
- **Read Data:** Tap to start performing diagnostics.
- **Import Data:** Tap to save the recorded results of the diagnostics on a file.

## Viewing Cradle Information

1. Touch **Info** tab.

Figure 30 Cradle Utility - Info Tab

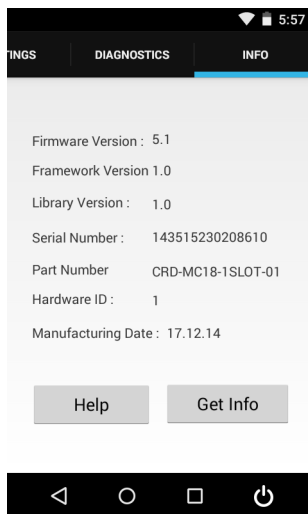

## Smart Cradle Configuration

The Smart Cradle Configuration app (**CradleSmartConfig**) avoids the need to manually enter the row, column, and wall ID's during the cradle wall configuration. Unlike using the Cradle Utility, where these values are entered for each slot, **CradleSmartConfig** guides the user through the configuration process. Additionally, the app implements automatic error checks and provides auditing mechanisms (Quick/Full) once the configuration is completed.

Use **CradleSmartConfig** to:

- Declare the wall map (row, column, wall, current)
- Declare empty/blank spots (kiosk, TV, computer monitor, or unique store shapes)
- Follow a screen guided sequence to read/program each slot based on the guided map
- Catch errors (duplication, skipped slots, and non-programmed slots).

## Support

**CradleSmartConfig** supports the following:

- Single slot and three slot cradles.
- Selectively removing certain cradle slots from the matrix, as placeholders for a kiosk, TV, computer monitor, or unique store shapes.
- Scrolling the screen left/right and up/down.
- A panning view of the cradle wall to be shown below the cradle icons as an indication of where the current focus is.

## Prerequisites/Assumptions

**CradleSmartConfig** requires the following prerequisites or assumes the following:

- The customer knows by a paper map or plan what the rows and columns should be set to for the wall.
- The wall is rectangular.
- Empty/blank spots are known (spots that do not have cradles).
- All three slot cradles should be the same type.
- SmartCradleConfig is installed on the device before starting.
- The default charging rate setting is 1A.

## Error Prevention

**CradleSmartConfig** helps prevent user errors by:

- Detecting if a slot has already been programmed properly.
- Detecting if a slot was missed (for example, 1,2,3,1,2,3,2,3)
- Providing screen guides as to the direction of the next slot to program.
- Guiding when to move up or down a row.
- Visual cues when an error is made.
- Automatically programming Wall/Row/Column/Current once it has detected it moved to the proper next slot.
- Signaling when ready to move to the next slot.

## Accessing CradleSmartConfig

To access CradleSmartConfig:

1. Go to the Zebra Support & Downloads web site for the PS20, [zebra.com/ps20-info](http://zebra.com/ps20-info).
2. Download **CradleSmartConfig** to a host computer.



**NOTE:** This app is not pre-loaded on the device and must be downloaded and installed prior to use.

3. Use the sideload process to copy the **CradleSmartConfig.apk** file onto a single PS20 device.
4. Install the app.

## Using CradleSmartConfig

To configure the cradle wall using CradleSmartConfig:



**NOTE:** Prior to using CradleSmartConfig, all new cradles should be mounted to a wall, including all power connections. It is assumed that no programming has occurred and all cradles are functioning with a unique serial number programmed in them from the factory.

1. Swipe up from the bottom of the Home screen and touch **CradleSmartConfig** .

The **CradleSmartConfig** screen displays.

Figure 31 CradleSmartConfig Screen

2. Complete the following:
  - **Rows** - The cradle row number in the dispenser wall.
  - **Columns** - The column number in the dispenser wall.
  - **Wall ID** - The number of dispenser wall where the cradle is positioned.
  - **Fast Charge** - Touch to enable the cradle to charge the PS20 at a current of 1.5A (default setting is 1A).
  - **SHD Mode** - Touch to enable super high density (SHD) mode, where the cradles are mounted horizontal to the ground.



**NOTE:** The cradle ID, location, and charging rate are retained across firmware upgrades.

3. Select **SINGLE SLOT** to program a wall of single slot cradles or select **THREE SLOT** to program a wall of three slot cradles.

A map of cradle icons display, based on the number of rows and columns entered in the previous step. For reference, the top left corner is Row 1, Column 1 (R1C1).

4. (Optional) Navigate around the screen.

To scroll left/right and up/down:

- a. Touch and drag your finger on the screen.
- b. Locate the graphic on the bottom of the screen to show where you are on the map. Scroll bars allow you to drag the screen to see a portion of the total wall.

5. (Optional) Delete cradle slots not used. For example, placeholders for a kiosk, TV, computer monitor, or unique store shapes.

To delete cradle slots:

- a. Touch and hold (long press) the cradle slot icon.
- b. Select **DELETE** to confirm.

Figure 32 Delete Cradle

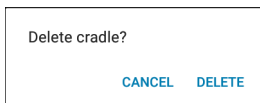

6. Insert a PS20 device in the first cradle in the top left corner (Row 1, Column 1).

7. Touch **Start**.

A Warning dialog displays indicating the correct sequence to follow when configuring the cradles.

8. Select **Ok**.

CradleSmartConfig programs the row, column, and wall information onto the cradle.

Figure 33 Warning Dialog - Follow Specified Order

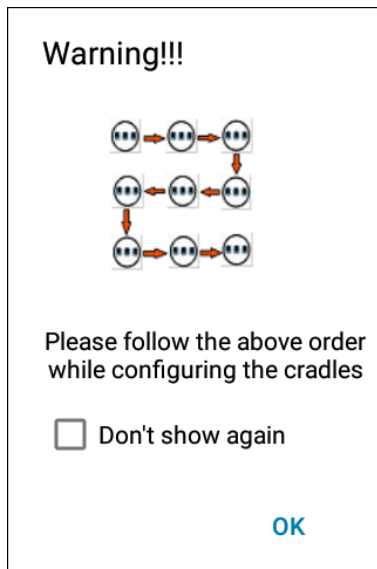

After the first cradle is programmed successfully, a check mark appears in the location of the cradle icon and an arrow on the screen points in the direction of where to insert the device in the next slot. An audible sound or visual cradle charge indication may be present.



- Remove the device from the first cradle, and move in the specified direction to insert the device in the next slot.

CradleSmartConfig directs the user to move in the proper direction. If the device is inserted into the wrong slot, the user is prompted.

Figure 34 Warning! Wrong Slot

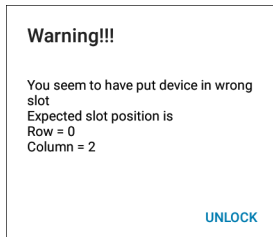

If the device is inserted into the same slot, a message indicates that the cradle has already been configured.

Figure 35 Warning! Cradle Already Configured

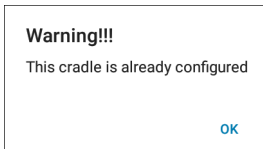

Note that each slot on the Three Slot Cradle needs to be programmed separately. The app guides the user to change rows in a zig-zag pattern for efficiency, with the first row going from left to right with serial numbers (last digits) 1,2,3 and the next row going from right to left with serial numbers (last digits) 3,2,1. The app also guides the user to skip the empty or blank areas. In a single slot cradle, the HW serial number last digit is 0.

- Moving in the direction specified, repeat until all cradles are configured.

If the user abandons programming before the entire wall is completed, the user must start over from the beginning.

Figure 36 Warning! Restart Configuration Screen

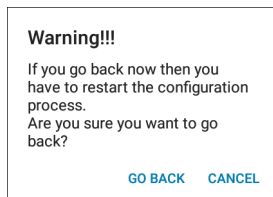

The app detects when it has reached the end of the wall and the **Configuration complete** dialog displays.

Figure 37 Configuration Complete Dialog

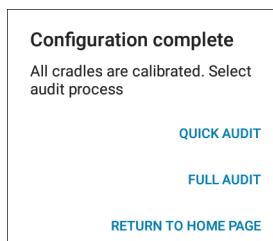

11. Select one of the following:

- **QUICK AUDIT** - A sample of cradles are validated and the expected data is compared to what is actually found. Blinking cradles are displayed one after the other at the four corners. The device to be validated should be placed in the middle slot of the blinking icon.
- **FULL AUDIT** - All cradles are validated and the expected data is compared to what is actually found.
- **RETURN TO HOME PAGE** - Displays the CradleSmartConfig screen.

## Auditing

Auditing validates that the cradles have been programmed correctly. The expected results should match the results found.

### Quick Audit

To perform a quick audit:

1. The four corner cradles will blink one after another. Place the device in the middle slot of the first blinking cradle icon.

If the audit was successful and the expected results match the results found, a green screen displays. If the audit failed and the expected results do not match the results found, a red screen displays.

Figure 38 Successful Audit Screen

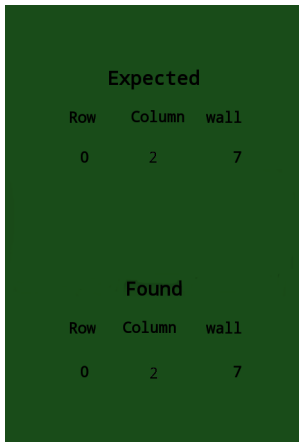

2. Moving in the direction specified, repeat until all cradles are validated.

The app detects when it has reached the end of the wall and the **Quick Audit complete** screen displays.

Figure 39 Quick Audit Complete Screen

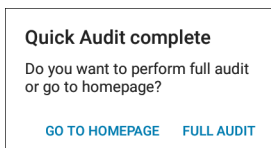

3. Select **FULL AUDIT** to perform a Full Audit or select **GO TO HOMEPAGE** to return to the **SmartCradleConfig** screen.

### Full Audit

To perform a Full Audit:

1. Place the device in the first cradle, first slot in the top left corner (Row 1, Column 1).  
The app detects the cradle in operation and starts validating the current slot.

Figure 40 Start Audit Process

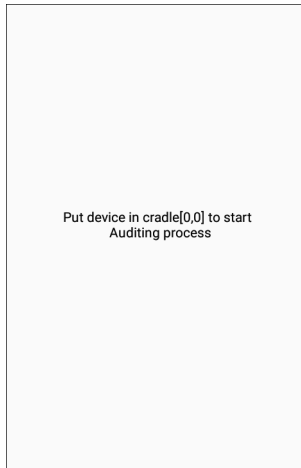

2. Moving in the direction specified, repeat until all cradles are validated.  
The app detects when it has reached the end of the wall and the **Full Audit is completed** screen displays.

Figure 41 Full Audit Complete Screen

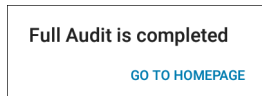

3. Select **GO TO HOMEPAGE** to return to the **SmartCradleConfig** screen.

## Wall Map Examples

Figure 42 Wall Map Examples

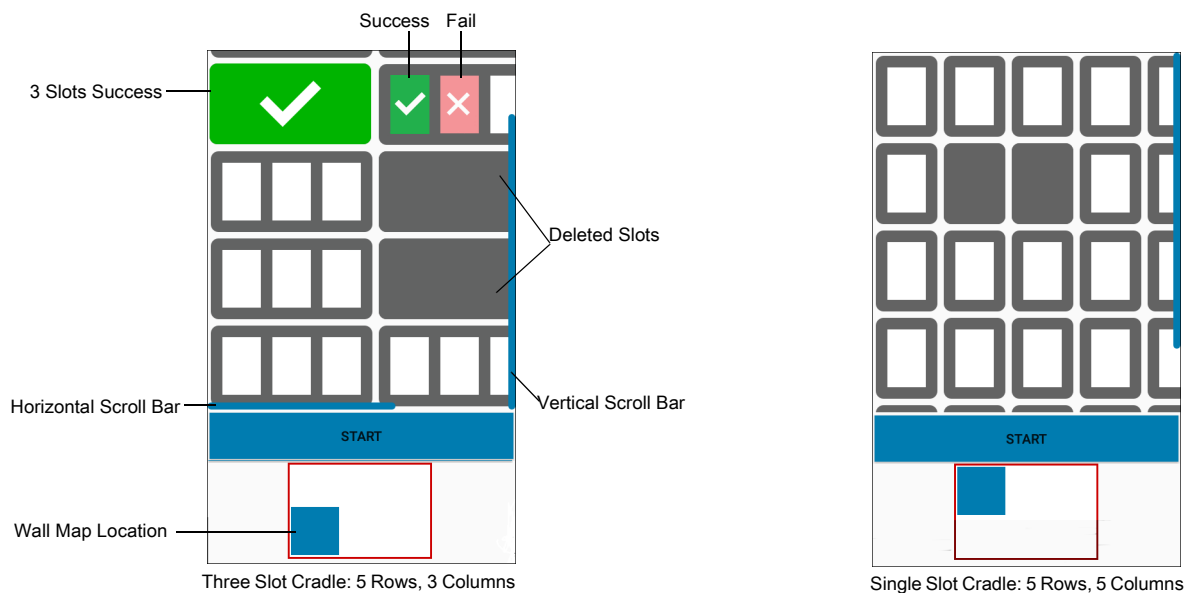









## DataWedge Demonstration



**NOTE:** DataWedge is enabled on the Home screen. To disable this feature, go to the DataWedge settings and disable the **Launcher** profile.

Use **DataWedge Demonstration** to demonstrate data capture functionality.

Table 14 DataWedge Demonstration Icons

	Icon	Description
Illumination		Imager illumination is on. Touch to turn illumination off.
		Imager illumination is off. Touch to turn illumination on.
Data Capture		The data capture function is through the internal imager.
		An RS6000 Bluetooth imager is connected.
		An RS6000 Bluetooth imager is not connected.
Scan Mode		Imager is in picklist mode. Touch to change to normal scan mode.
		Imager is in normal scan mode. Touch to change to picklist mode.
		Opens a menu to view the application information or to set the application DataWedge profile.



**NOTE:** To configure DataWedge, refer to [techdocs.zebra.com/datawedge/](http://techdocs.zebra.com/datawedge/).

## Scanner Selection

To select a scanner, touch  > **Settings** > **Scanner selection**.

See Data Capture for more information.

Either press the programmable button or touch the yellow scan button to capture data. The data appears in the text field below the yellow button.

## Device Central

**Device Central** displays detailed information about the device and connected peripherals and supports the following Zebra devices:

Device Central features include:

- Discovering and pairing with supported peripherals via Bluetooth or corded connection.
- Paging a connected RS6000 Ring Scanner.
- Displaying the connection status of peripherals.
- Displaying information for a connected peripheral in the notification bar.

Figure 43 Device Central Screen

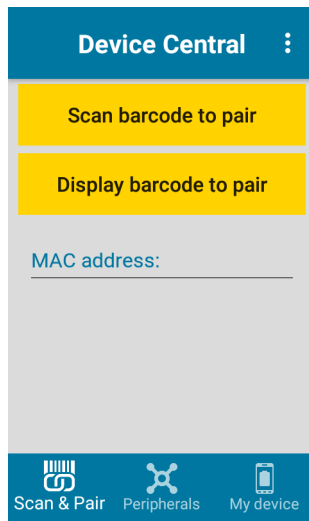

## Scan and Pair Tab

Pairing to a Bluetooth peripheral is accomplished by one of the following methods:

- Scan and Pair
- Scan to Pair
- Manually Pairing

### Scan and Pair

To scan the peripheral Bluetooth barcode to pair:

1. In the **Scan and Pair** tab, touch **Scan barcode to pair**. The peripheral's scan beam illuminates.
2. Ensure that Bluetooth is enabled on the peripheral and is set to discoverable mode. Refer to the peripheral user guide for instructions.
3. Scan the Bluetooth MAC address barcode label on the desired peripheral to pair.

When pairing is successful, the peripheral displays in the list. A green dot appears next to a Bluetooth scanner when the device is connected, and may be in use. A red dot appears next to other Bluetooth peripherals, such as a Bluetooth headset or printer, while they are connected but not in use.

## Scan to Pair

Use Scan and Pair to pair by scanning a barcode displayed on the screen. This applies to peripherals that have scanning capability, such as Bluetooth handheld scanners and ring scanners.

1. In the **Scan and Pair** tab, touch **Display barcode to pair**. A barcode displays.
2. Using the peripheral, scan the barcode on the screen.

When the pairing is successful, the peripheral displays in the list with a green dot indicating that it is paired.

## Manually Pairing

To manually pair a peripheral that is unable to pair via Bluetooth:

1. In the **Scan and Pair** tab, touch the **MAC address** field.
2. Enter the Bluetooth MAC address of the peripheral.
3. Touch **Pair**.

When pairing is successful, the peripheral displays in the list. A green dot appears next to a Bluetooth scanner when the device is connected, and may be in use. A red dot appears next to other Bluetooth peripherals, such as a Bluetooth headset or printer, while they are connected but not in use.

## Peripherals Tab

The **Peripherals** Tab displays all currently connected and previously connected peripherals. Connected peripherals display the length of time (in minutes) that they have been connected.

Touch the connected device icon to display details about the peripheral. The **Device Details** screen appears. When an RS6000 is connected the **Page** button displays at the bottom of the **Device Details** screen. See Paging an RS6000 Ring Scanner.

## My Device Tab

The **My Device** Tab displays information about the device.

- **Device Model** - Displays the name assigned to the device.
- **Device Serial Number** - Displays the serial number of the device.
- **OS Version** - Displays the operating system version.
- **Build Number** - Displays the software build number.
- **Battery Level** - The current battery charge level as a percentage.
- **Battery Part Number** - The battery part number.
- **Battery Serial Number** - The battery serial number. The number matches the serial number printed on the battery label.
- **Battery Manufactured Date** - The date of manufacture.

## Unpairing a Peripheral

To unpair a Bluetooth peripheral:

1. In the **Scan and Pair** tab, touch **Unpair** for the desired peripheral to unpair.  
A confirmation pop-up message appears.

2. Touch **OK**.

Once unpaired, a message appears indicating the peripheral has been disconnected, and the peripheral is removed from the list.

### Paging an RS6000 Ring Scanner

Use **Page** button to easily locate the currently connected RS6000 Ring Scanner:

1. With the RS6000 Ring Scanner connected, swipe up from the bottom of the Home screen, and touch .



**NOTE:** The RS6000 Ring Scanner must be within 10 m (32 ft) of the device.

2. Under the RS6000 peripheral information, touch **Page** to page the RS6000. The paged RS6000 beeps and vibrates.

To stop paging, press the scan trigger of the RS6000. On a triggerless RS6000, reset the RS6000 to stop paging. Refer to the RS6000 User Guide.

## Diagnostic Tool

The **Diagnostic Tool** is a utility that determines the health of the device. Use the Diagnostic Tool to troubleshoot the device.

1. Swipe up from the bottom of the Home screen and touch .
2. Touch **RUN TEST**. The app tests all enabled subsystems (by default, only the Battery and System tests). See Settings to enable subsystem tests.
3. To view each subsystem test, touch **Subsystem Tests**.

Figure 44 Subsystem Screen



4. Touch one of the subsystems to view details.

Table 15 Subsystem Test Result Indicators

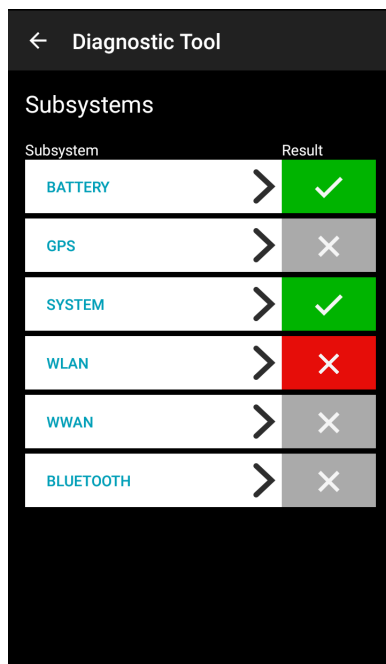

Status Icon	Description
	Test passed.
	Test failed.
	Test not supported or not enabled.



Figure 45 Battery Subsystem Details

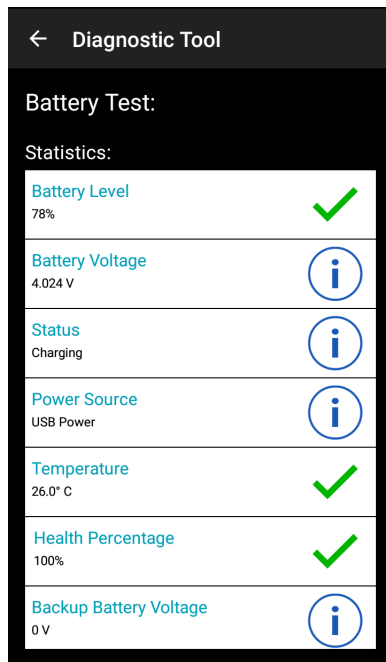

## Settings

By default only the Battery and System tests are enabled. To enable other tests:

1. Touch **☰** > **Settings**.
2. Touch to the left of the test name. A green box with a checkmark appears.
3. Touch **SAVE**.
4. Touch **Yes** to confirm.
5. Touch **◀**.

## Battery Test Information

The Battery Test obtains the following information:

- **Battery Level** - Current battery charge level
- **Battery Voltage** - Current battery voltage
- **Status** - Whether the battery is charging (on AC power) or discharging (on battery power)
- **Power Source** - Whether the device is receiving power from the battery or from an external source
- **Temperature** - Current battery temperature
- **Health Percentage** - Indicates the ratio of present capacity to design capacity at a discharge rate of design capacity.
- **Backup Battery Voltage** - Backup battery voltage.
- **Manufacture Date** - Manufacture date of the battery.

## GPS Test Information

Not supported on this device.

## System Test Information

Use the System Test to determine if the CPU or memory loads are too high, there are too many processes running on the device, or storage on the device is almost full.

The System Test obtains the following information:

- **CPU Load** - Amount of CPU being used
- **Free Physical Memory** - Amount of RAM available
- **Free Storage** - Amount of internal Flash memory available
- **Process Count** - Number of processes currently running.

## WLAN Test Information

If the WiFi radio is not present or disabled, skip this test. This test determines if the device's WLAN configuration is correct or whether there is any connection with an access point or network.

The WLAN test obtains the following information:

- **WLAN Enabled** - WLAN radio is enabled or disabled
- **WLAN Status** - Current status of association with the access point
- **ESSID** - Name of the wireless network
- **BSSID** - MAC address of the connected access point
- **MAC Address** - Device's MAC address
- **Signal** - Strength of the Wi-Fi signal (in dBm)
- **IP Address** - IP address of the device.

## WWAN Test Information

Not supported on this device.

## Bluetooth Test Information

The Bluetooth Test obtains the following information:

- **Enabled** - Whether the Bluetooth radio is enabled or disabled
- **Status** - Whether the device is paired to another Bluetooth device
- **Connectable/Discoverable** - Whether the device is discoverable or able to connect
- **Address** - Bluetooth radio MAC address
- **Name** - Bluetooth name for the device.

## Enterprise Browser

The Enterprise Browser is an industrial browser that provides everything needed to quickly build device apps for barcode scanning, signature capture, payment processing, printing and most other enterprise applications.

Enterprise Browser includes a runtime environment inside which a company's application logic can be executed and controlled using HTML5 and CSS3 for presentation and JavaScript to access Enterprise Browser APIs for scanners, cameras, card readers and other device peripherals.

The base Enterprise Browser installation includes all necessary components to allow a Windows development host to easily build device apps and set runtime settings for local or mass-deployment using Zebra StageNow or a mobile device management (MDM) system. If migrating from another platform, Enterprise Browser also can run apps built for PocketBrowser, making it an ideal path for moving apps to a newer UI, device or platform.

For more information, refer to [techdocs.zebra.com/enterprise-browser/](http://techdocs.zebra.com/enterprise-browser/).

## Enterprise Browser Application

The device comes with an Enterprise Browser application pre-licensed and pre-loaded. The application is accessible from the apps screen.

1. Swipe up from the bottom of the Home screen, and touch **EnterpriseBrowser**.

Figure 46 Enterprise Browser Screen

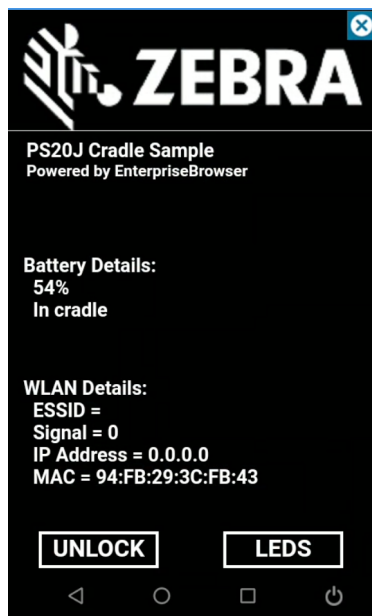

The default Enterprise Browser page provides the following information:

- Battery Details:
  - Battery strength in percentage
  - Whether in cradle or not

- WLAN Details:
  - ESSID name
  - Signal
  - IP Address of the device
  - MAC address of the device

The buttons at the bottom of the screen:

- UNLOCK - Unlocks the device in the cradle.
- LEDS - Illuminates the cradle LEDs.

## RxLogger

RxLogger is a comprehensive diagnostic tool that provides application and system metrics, allows for the creation of custom plug-ins, and diagnoses device and application issues. RxLogger logs the following information: CPU load, memory load, memory snapshots, battery consumption, power states, wireless logging, cellular logging, TCP dumps, Bluetooth logging, GPS logging, logcat, FTP push/pull, ANR dumps, etc. All generated logs and files are saved onto flash storage on the device (internal or external).

### RxLogger Configuration

RxLogger is built with an extensible plug-in architecture and comes packaged with a number of plug-ins already built-in. For information on configuring RxLogger, refer to [techdocs.zebra.com/rxlogger/](http://techdocs.zebra.com/rxlogger/).



To open the configuration screen, from the RxLogger home screen touch **Settings**.

### Configuration File

RxLogger configuration can be set using an XML file. The `config.xml` configuration file is located in the `RxLogger\config` folder. Copy the file from the device to a host computer using a USB connection. Edit the configuration file and then replace the XML file on the device. There is no need to stop and restart the RxLogger service since the file change is automatically detected.

### Enabling Logging

To enable logging:

1. Swipe the screen up and select .
2. Touch **Start**.
3. Touch .

### Disabling Logging

To disable logging:

1. Swipe the screen up and select .
2. Touch **Stop**.

3. Touch ○.

## Extracting Log Files

1. Connect the device to a host computer using an USB connection.
2. Using a file explorer, navigate to the **RxLogger** folder.
3. Copy the file from the device to the host computer.
4. Disconnect the device from the host computer.

## Backup

RxLogger Utility allows the user to make a zip file of the **RxLogger** folder in the device, which by default contains all the RxLogger logs stored in the device.

To save the backup data, touch  > **BackupNow**.

## RxLogger Utility

RxLogger Utility is a data monitoring application for viewing logs in the device while RxLogger is running. Logs and RxLogger Utility features are accessed using Main Chat Head.

### Initiating the Main Chat Head

To initiate the Main Chat Head:

1. Open **RxLogger**.
2. Touch  > **Toggle Chat Head**. The Main Chat Head icon appears on the screen.
3. Touch and drag the Main Chat head icon to move it around the screen.

### Removing the Main Chat Head

To remove the Main Chat Head icon:

1. Touch and drag the icon. A circle with an X appears.
2. Move the icon over the circle and then release.

### Viewing Logs

To view logs:

1. Touch the Main Chat Head icon. The RxLogger Utility screen appears.
2. Touch a log to open it. The user can open many logs with each displaying a new sub Chat Head.
3. If necessary, scroll left or right to view additional Sub Chat Head icons.
4. Touch a Sub Chat Head to display the log contents.

### Removing a Sub Chat Head Icon

To remove a sub chat Head icon, press and hold the icon until it disappears.

### Backing Up In Overlay View

RxLogger Utility allows the user to make a zip file of the **RxLogger** folder in the device, which by default contains all the RxLogger logs stored in the device.

The Backup icon is always available in Overlay View.

1. Touch . The Backup dialog box appears.
2. Touch **Yes** to create the back up.

## Sound Recorder

Use **Sound Recorder** to record audio messages.

Recordings are saved on the microSD card (if installed) or the internal storage and are available in the Music application (non-GMS devices) or the Play Music application (GMS devices).

Touch  to open options menu.

- **File type** - Select the file type for the recording file.
  - **AMR**
  - **3GPP**
  - **AAC**
  - **WAV**
  - **AMR-WR**
  - **AMR-WB-3GPP.**
- **Storage location** - Select the location for the recording file.
  - **Phone storage.**

# Data Capture

## Introduction

The PS20 imager allows collection of data by scanning bar codes.

The imager has the following features:

- Reads a variety of bar code symbologies, including the most popular linear, postal, and 2-D code types (see Specifications).
- Contains advanced intuitive aiming light for easy point-and-shoot operation.



**NOTE:** Bluetooth scanners are not supported.

## Scanning Considerations

Typically, scanning is a simple matter of aim, scan, and decode, with a few quick trial efforts to master it. However, consider the following to optimize scanning performance:

- **Range:** Scanners decode best over a particular working range — minimum and maximum distances from the barcode. This range varies according to barcode density and scanning device optics. Scan within range for quick and constant decodes; scanning too close or too far away prevents decodes. Move the scanner closer and further away to find the right working range for the barcodes being scanned.
- **Angle:** Scanning angle is important for quick decodes. When the illumination/flash reflects directly back into the imager, the specular reflection can blind/saturate the imager. To avoid this, scan the barcode so that the beam does not bounce directly back. Do not scan at too sharp an angle; the scanner needs to collect scattered reflections from the scan to make a successful decode. Practice quickly shows what tolerances to work within.
- Hold the device farther away for larger symbols.
- Move the device closer for symbols with bars that are close together.



**NOTE:** Scanning procedures depend on the app and device configuration. An app may use different scanning procedures from the one listed above.

## Scanning Bar Codes

To scan a barcode:

1. Launch a scanning application.
2. Press the Scan key and aim the device at a barcode.



3. Adjust the position of the device so that the:

- Red aiming dot appears at the center of the barcode on devices with the SE4710 imager.
- White LED appears around the barcode on devices with the SE2100 imager.

Ensure the barcode is within the area formed by the aiming pattern. On devices with the SE4710 imager, the aiming dot is used for increased visibility in bright lighting conditions.

4. Press the Scan key.

The Status LED illuminates red. Upon successful decode, the Status LED changes from red to green and an audible beep sounds.

Figure 47 SE4710 Imager Decode Mode

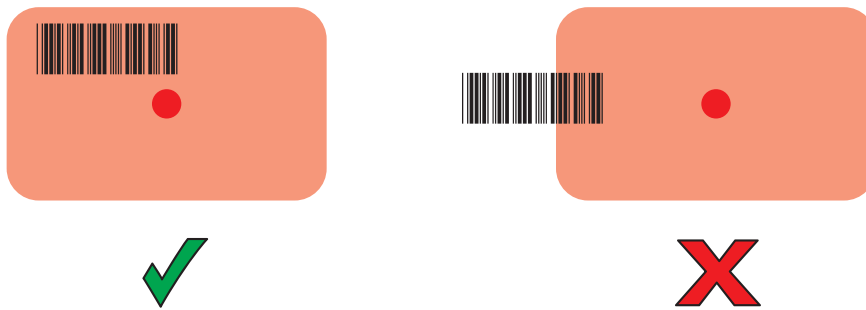
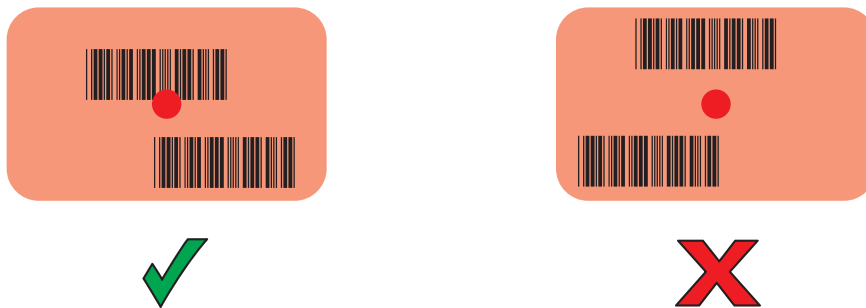

Figure 48 SE4710 Imager Picklist Mode



**NOTE:** Picklist Mode is only available on the PS20 with the SE4710 imager. When the PS20 is in Picklist Mode, the imager does not decode the barcode until the crosshair or aiming dot touches the barcode.

Figure 49 SE2100 Imager Decode Mode



5. Release the Scan key.

The barcode data displays on the screen.

## Scanning Tips

Optimal scanning distance varies with bar code density and scanner optics.

- Hold the scanner farther away for larger symbols.
- Move the scanner closer for symbols with bars that are close together.



**NOTE:** Scanning procedures depend on the application and PS20 configuration. An application may use different scanning procedures from the one listed above.

## Decode Screen Notification

Scan Params in DataWedge includes an option for **Decode Screen Notification**. Enable this option to display a translucent green screen overlay as a notification for each successful decode. In addition, Scan Params includes options for **Decode Screen Notification Timer** and **Decode Screen Translucency Level**, which allow you to set the green screen overlay time in milliseconds and the level of translucency.



**NOTE:** For **Decode Screen Notification** to work, **Display over other apps** permission must be granted for the application.

Figure 50 Translucent Green Overlay Decode Screen Notification



## Hands Free Scanning

Hands Free Scanning allows the user to capture barcode data when a barcode is placed within the view of the device without pressing the trigger. Hands Free Scanning is enabled using the **Hands Free Trigger** settings or when the device is placed in the cart/mount. Hands Free Scanning is set to disabled by default.

## Settings

Use the Hands Free Trigger setting to configure scanning mode and the proximity trigger sensitivity.

Swipe down from the Status bar to open the Quick Access panel and then touch  > **Hands Free Trigger**.

Figure 51 Hands Free Trigger Settings

← Hands Free Trigger	
Scanning Mode	Hands Free Off
Proximity Trigger Range	Near

## Scanning Mode

Use the **Scanning Mode** settings to configure how the device functions while in hands free scanning mode.

Figure 52 Scanning Mode Dialog Box

Scanning Mode	
<input type="radio"/>	Hands Free in Cart/ Mount
<input type="radio"/>	Hands Free Always On
<input checked="" type="radio"/>	Hands Free Off
CANCEL	

- **Hands Free in Cart/Mount** - Select to enable scanning when the device is in the cart/mount. The device detects the difference between in-motion and stationary states. When the device is in the Motion state, proximity scanning is disabled. When the device is in the Stationary state or in a hands free cart/mount, proximity scanning is enabled.
- **Hands Free Always On** - Select to place the device in hands free scanning mode.
- **Hands Free Off** - Select to disable hands free scanning mode (default).



**NOTE:** In order to use the **Hands Free in Cart/Mount** scanning mode, the devices in a store must be calibrated to the cart orientation first. If the hands free scanning mode is enabled, and if the device is properly calibrated, the device will be detected that it's in a cart and enable the hands free trigger. While in the cart, the device displays a shopping cart notification in the status bar. For more information about creating and deploying the calibration file, see the PS20 Personal Shopper Calibration App User Guide at [zebra.com/ps20-info](https://zebra.com/ps20-info).

## Proximity Range

To configure the proximity sensor range sensitivity, touch **Proximity Trigger Range**.

Figure 53 Proximity Trigger Range Dialog Box

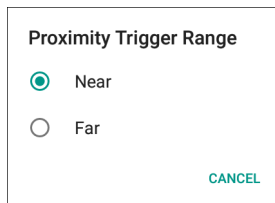



- **Near** - Proximity sensor detects and generates a trigger when the barcode is within 0 to 20 cm (nominal) (default).
- **Far** - Proximity sensor detects and generates a trigger when the barcode is within 0 to 60 cm (nominal).

## DataWedge



DataWedge is a utility that adds advanced barcode scanning capability to any application without writing code. It runs in the background and handles the interface to built-in barcode scanners. The captured barcode data is converted to keystrokes and sent to the target application as if it was typed on the keypad.

To configure DataWedge refer to [techdocs.zebra.com/datawedge](http://techdocs.zebra.com/datawedge).

### Enabling DataWedge

1. Swipe up from the bottom of the screen and touch .
2. Touch  > **Settings**.
3. Touch **DataWedge enabled**.  
A blue checkmark appears in the checkbox indicating that DataWedge is enabled.
4. Touch .

### Disabling DataWedge

1. Swipe up from the bottom of the screen and touch .
2. Touch  > **Settings**.
3. Touch **DataWedge enabled**.  
A blue checkmark disappears from the checkbox indicating that DataWedge is disabled.
4. Touch .

## Decoders

Configures which barcode decoders are enabled or disabled. For best performance disable all unnecessary decoders.

Touch **Decoders**. The **Barcode input** screen appears. A check in the checkbox indicates that the decoder is enabled. By default the most commonly used decoders are enabled (shown below with an asterisk). The supported decoders are:



**NOTE:** DataWedge supports the decoders listed below but not all are validated on this device.

*Table 16 Supported Decoders*

Decoders	Internal Imager SE2100	Internal Imager SE4710
Australian Postal	O	O
Aztec	X	X
Canadian Postal	O	O
Chinese 2 of 5	O	O
Codabar	X	X
Code 11	O	O
Code 128	X	X
Code 39	X	X
Code 93	O	O
Composite AB	O	O
Composite C	O	O
Discrete 2 of 5	O	O
Datamatrix	X	X
Dutch Postal	O	O
DotCode	O	O
EAN13	X	X
EAN8	X	X
GS1 DataBar	X	X
GS1 DataBar Expanded	X	X
GS1 DataBar Limited	O	O
GS1 Datamatrix	O	O
GS1 QRCode	O	O
HAN XIN	O	O

Table 16 Supported Decoders (Continued)

Decoders	Internal Imager SE2100	Internal Imager SE4710
Interleaved 2 of 5	O	O
Japanese Postal	O	O
Korean 3 of 5	O	O
MAIL MARK	X	X
Matrix 2 of 5	O	O
Maxicode	X	X
MicroPDF	O	O
MicroQR	O	O
MSI	O	O
PDF417	X	X
QR Code	X	X
Decoder Signature	O	O
TLC 39	O	O
Trioptic 39	O	O
UK Postal	O	O
UPCA	X	X
UPCE0	X	X
UPCE1	O	O
US4state	O	O
US4state FICS	O	O
US Planet	O	O
US Postnet	O	O

Touch  to return to the previous screen.

# Wireless

This section provides information on the wireless features:

- Wireless Local Area Network (WLAN)
- Bluetooth
- Cast.

## Wireless Local Area Networks

Wireless local area networks (WLANs) allow the device to communicate wirelessly inside a building. Before using the device on a WLAN, the facility must be set up with the required hardware to run the WLAN (sometimes known as infrastructure). The infrastructure and the device must both be properly configured to enable this communication.

Refer to the documentation provided with the infrastructure (access points (APs), access ports, switches, Radius servers, etc.) for instructions on how to set up the infrastructure.

Once the infrastructure is set up to enforce the chosen WLAN security scheme, use the **Wireless & networks** settings configure the device to match the security scheme.

The device supports the following WLAN security options:

- Open
- Wireless Equivalent Privacy (WEP)
- Wi-Fi Protected Access (WPA)/WPA2 Personal (PSK)
- Extensible Authentication Protocol (EAP).
  - LEAP
  - Protected Extensible Authentication Protocol (PEAP) - with MSCHAPV2 and GTC authentication
  - Transport Layer Security (TLS)
  - TTLS - with Password Authentication Protocol (PAP), MSCHAP and MSCHAPv2 authentication.
  - PWD



The **Status** bar displays icons that indicate Wi-Fi network availability and Wi-Fi status.



**NOTE:** To extend the life of the battery, turn off Wi-Fi when not in use.

## Accessing Settings

Access Settings in any of the following ways:

- Swipe down with two fingers from the top of the Home screen to open the Quick Access panel and touch .
- Double-swipe down from the top of the Home screen to open the Quick Access panel and touch .
- Swipe up from the bottom of the Home screen to open APPS and touch  **Settings**.

## Connecting to a Wi-Fi Network

To connect to a Wi-Fi network:

1. Go to **Settings**.
2. Touch **Wi-Fi** to open the **Wi-Fi** screen. The device searches for WLANs in the area and lists them.

Figure 54 Wi-Fi Screen

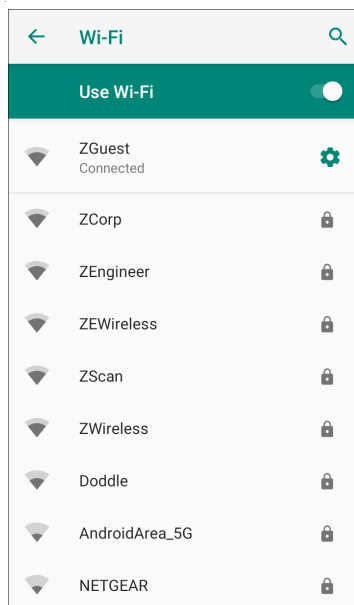

3. Scroll through the list and select the desired WLAN network.
4. For open networks, touch profile once or press and hold and then select **Connect to network** or for secure networks enter the required password or other credentials then touch **Connect**. See the system administrator for more information.

The device obtains a network address and other required information from the network using the dynamic host configuration protocol (DHCP) protocol. To configure the device with a fixed internet protocol (IP) address, Refer to the device Integrator Guide for more information.

5. In the Wi-Fi setting field, **Connected** appears indicating that the device is connected to the WLAN.

## Removing a Wi-Fi Network

To remove a remembered or connected network:



1. Go to **Settings**.
2. Touch **Network & Internet > W-Fi**.
3. Scroll down to the bottom of the list and touch **Saved networks**.
4. Touch the name of the network.
5. In the dialog box, touch **FORGET**.
6. Touch .

## WLAN Configuration

### Configuring a Secure Wi-Fi Network

To set up a Wi-Fi network:

1. Go to **Settings**.
2. Touch **Network & Internet > Wi-Fi**.
3. Slide the switch to the **ON** position.
4. The device searches for WLANs in the area and lists them on the screen.
5. Scroll through the list and select the desired WLAN network.
6. Touch the desired network. If the network security is **Open**, the device automatically connects to the network. For all other network security a dialog box appears.
7. If the network security is **WEP** or **WPA/WPS2 PSK**, enter the required password and then touch **Connect**.
8. If the network security is 802.1x EAP:
  - Touch the **EAP method** drop-down list and select **PEAP**, **TLS**, **TTLS**, **PWD**, or **LEAP**.
  - Touch the **Phase 2 authentication** drop-down list and select an authentication method.
  - If required, touch **CA certificate** and select a Certification Authority (CA) certificate. Note: Certificates are installed using the **Security** settings.
  - If required, touch **User certificate** and select a user certificate. Note: User certificates are installed using the Location & security settings.
  - If required, in the **Identity** text box, enter the username credentials.
  - If desired, in the **Anonymous identity** text box, enter an anonymous identity username.
  - If required, in the **Password** text box, enter the password for then given identity.



**NOTE:** By default, the network Proxy is set to **None** and the IP settings is set to **DHCP**. See Configuring for a Proxy Server for setting connection to a proxy server and see Configuring the Device to Use a Static IP Address for setting the device to use a static IP address.

9. Touch **Connect**.
10. Touch .

## Manually Adding a Wi-Fi Network

Manually add a Wi-Fi network if the network does not broadcast its name (SSID) or to add a Wi-Fi network when out of range.

1. Go to **Settings**.
2. Touch **Network & Internet > Wi-Fi**.
3. Slide the Wi-Fi switch to the **On** position.
4. Scroll to the bottom of the list and select **Add network**.
5. In the **Network name** text box, enter the name of the Wi-Fi network.
6. In the **Security** drop-down list, set the type of security to:
  - **None**
  - **WEP**
  - **WPA/WPA2 PSK**
  - **802.1x EAP**.
7. If the network security is **None**, touch **Save**.
8. If the network security is **WEP** or **WPA/WPA2 PSK**, enter the required password and then touch **Save**.
9. If the network security is **802.1x EAP**:
  - Touch the **EAP method** drop-down list and select **PEAP**, **TLS**, **TTLS**, **PWD**, or **LEAP**.
  - Touch the **Phase 2 authentication** drop-down list and select an authentication method.
  - If required, touch **CA certificate** and select a Certification Authority (CA) certificate. Note: Certificates are installed using the **Security** settings.
  - If required, touch **User certificate** and select a user certificate. Note: User certificates are installed using the **Security** settings.
  - If required, in the **Identity** text box, enter the username credentials.
  - If desired, in the **Anonymous** identity text box, enter an anonymous identity username.
  - If required, in the **Password** text box, enter the password for the given identity.



**NOTE:** By default, the network Proxy is set to **None** and the IP settings is set to **DHCP**. See Configuring for a Proxy Server for setting connection to a proxy server and see Configuring the Device to Use a Static IP Address for setting the device to use a static IP address.

10. Touch **Save**. To connect to the saved network, touch and hold on the saved network and select **Connect to network**.
11. Touch .

## Configuring for a Proxy Server

A proxy server is a server that acts as an intermediary for requests from clients seeking resources from other servers. A client connects to the proxy server and requests some service, such as a file, connection, web page, or other resource, available from a different server. The proxy server evaluates the request according to its filtering rules. For example, it may filter traffic by IP address or protocol. If the request is validated by the filter, the proxy provides the resource by connecting to the relevant server and requesting the service on behalf of the client.

It is important for enterprise customers to be able to set up secure computing environments within their companies, making proxy configuration essential. Proxy configuration acts as a security barrier ensuring that the proxy server monitors all traffic between the Internet and the intranet. This is normally an integral part of security enforcement in corporate firewalls within intranets.

To configure the device for a proxy server:

1. Go to **Settings**.
2. Touch **Network & Internet > Wi-Fi**.
3. Slide the Wi-Fi switch to the **On** position.
4. In the network dialog box, select and touch a network.
5. Touch **Advanced options**.
6. Touch **Proxy** and select **Manual**.
7. In the **Proxy hostname** text box, enter the address of the proxy server.
8. In the **Proxy port** text box, enter the port number for the proxy server.
9. In the **Bypass proxy for** text box, enter addresses for web sites that are not required to go through the proxy server. Use a comma “,” between addresses. Do not use spaces or carriage returns between addresses.
10. Touch **Connect**.
11. Touch .

## Configuring the Device to Use a Static IP Address

By default, the device is configured to use Dynamic Host Configuration Protocol (DHCP) to assign an Internet protocol (IP) address when connecting to a wireless network.

To configure the device to connect to a network using a static IP address:

1. Go to **Settings**.
2. Touch **Network & Internet > Wi-Fi**.
3. Slide the Wi-Fi switch to the **On** position.
4. In the network dialog box, select and touch a network.
5. Touch **Advanced options**.
6. Touch **IP settings** and select **Static**.
7. In the **IP address** text box, enter an IP address for the device.
8. If required, in the **Gateway** text box, enter a gateway address for the device.
9. If required, in the **Network prefix length** text box, enter the prefix length.
10. If required, in the **DNS 1** text box, enter a Domain Name System (DNS) address.
11. If required, in the **DNS 2** text box, enter a DNS address.
12. Touch **Connect**.

13. Touch .

## Wi-Fi Preferences

Use the **Wi-Fi preferences** to configure advanced Wi-Fi settings. From the Wi-Fi screen scroll down to the bottom of the screen and touch **Wi-Fi preferences**.

- **Turn on W-Fi automatically** - When enabled, Wi-Fi automatically turns back on when near high quality saved networks.
- **Open network notification** - When enabled, notifies the user when an open network is available.
- **Advanced - Touch to expand options.**
  - **Additional settings** - See Additional Settings.
  - **Install Certificates** – Touch to install certificates.
  - **Network rating provider** - Disabled (AOSP devices). To help determine what constitutes a good Wi-Fi network, Android supports external Network rating providers that provide information about the quality of open Wi-Fi networks. Select one of the providers listed or **None**. If none are available or selected, the Connect to open networks feature is disabled.
  - **Wi-Fi Direct** - Displays a list of devices available for a direct Wi-Fi connection.
  - **MAC address** - Displays the Media Access Control (MAC) address of the device when connecting to Wi-Fi networks.
  - **IP address** - Displays the IP address of the device when connecting to Wi-Fi networks.

## Additional Wi-Fi Settings



**NOTE:** Additional Wi-Fi settings are for the device, not for a specific wireless network.

Use the **Additional Settings** to configure additional Wi-Fi settings. To view the additional Wi-Fi settings, scroll to the bottom of the **Wi-Fi** screen and touch **Wi-Fi Preferences > Advanced > Additional settings**.

- **Regulatory**
  - **Country Selection** - Displays the acquired country code if 802.11d is enabled, else it displays the currently selected country code.
  - **Region code** - Displays the current region code.
- **Band and Channel Selection**
  - **Wi-Fi frequency band** - Set the frequency band to: **Auto** (default), **5 GHz only** or **2.4 GHz only**.
  - **Available channels (2.4 GHz)** - Touch to display the **Available channels** menu. Select specific channels and touch **OK**.
  - **Available channels (5 GHz)** - Touch to display the **Available channels** menu. Select specific channels and touch **OK**.
- **Logging**
  - **Advanced Logging** – Touch to enable advanced logging or change the log directory.
  - **Wireless logs** - Use to capture Wi-Fi log files.
    - **Fusion Logger** - Touch to open the **Fusion Logger** application. This application maintains a history of high level WLAN events which helps to understand the status of connectivity.
    - **Fusion Status** - Touch to display live status of WLAN state. Also provides information about the device and connected profile.

- **About**
  - **Version** - Displays the current Fusion information.

## Wi-Fi Direct

Wi-Fi Direct devices can connect to each other without having to go through an access point. Wi-Fi Direct devices establish their own ad-hoc network when required, letting you see which devices are available and choose which one you want to connect to.

1. Go to **Settings**.
2. Touch **Wi-Fi > Wi-Fi preferences > Advanced > Wi-Fi Direct**. The device begins searching for another Wi-Fi Direct device.
3. Under **Peer devices**, touch the other device name.
4. On the other device, select **Accept**.
5. **Connected** appears on the device. On both devices, in their respective Wi-Fi Direct screens, the other device name appears in the list.

## Wi-Fi Advanced Features

Some additional Wi-Fi settings cannot be accessed from the User Interface. They can be configured by using Wi-Fi (CSP). Refer to EMDK documentation for the details on the Wi-Fi settings configuration using the Wi-Fi CSP.

- **Auto Time Config** - Using this feature, the device can sync up its time with Zebra WLAN infrastructure. This feature works only when the device is connected to Zebra WLAN infrastructure and the feature is enabled on the WLAN infrastructure side. Default: disabled.
- **PMKID Caching** - Allows the device to skip 802.1x authentication during roaming if it had previously connected to that AP with a full 802.1x authentication. Default: disabled. Note: disable OKC when enabling PMKID Caching.
- **Opportunistic Key Caching** - Use this feature to skip 802.1x authentication during roaming. The device will go for full 802.1x authentication for the first time it connects to the network. For subsequent roaming, the device skips 802.1x authentication. Default: enabled.
- **Cisco Centralized Key Management** - Allows the device to skip 802.1x and key-handshake phases during roaming. This feature is available only when the device is connected to a Cisco infrastructure that supports Cisco Centralized Key Management (CCKM). Default: enabled.
- **Fast Transition** - Fast Transition (FT) is the fast roaming standard, 802.11r. With this feature, the device can skip 802.1x and key-handshake phases during roam. Default: enabled.
- **Fast Transition Resource Information Container** - Allows the device to request TSPEC as part of reassociation frame exchange. This helps to avoid sending a separate resource request after roaming is completed. Default: enabled.
- **Power Save** - The device can be configured to work in different power save modes:
  - i. **Active** - Keeps the WLAN radio always in active mode (i.e. power save mode disabled).
  - ii. **Power save using WMM-PS** - This is the default power save mode. Device uses WMM-PS power save method if the AP is configured to use this. If the AP is not supporting WMM-PS, the device will use PS-Poll power save method.
  - iii. **Power save using PS-Poll** - In this method, the device will use PS-Poll frames to retrieve buffered frames from the AP.

- iv. **Null Data Power Save** - In Null Data Power Save (NDP), the device will stay awake for 100 ms after the last frame is sent or received. The device will send a Null Data packet with power management bit cleared to retrieve buffered frames from the AP.
- **802.11k** - Using 802.11k, the device can discover neighbor APs and adds support for different types of radio resource measurements. Default: enabled.
- **Band Preference** - The device can be configured to prefer one band over another. Default: disabled. **Subnet Roaming** - When the device roams between different sub networks, if it detects that it is roaming to a different subnet, the device will request a fresh IP address. Default: disabled.

## Bluetooth

Bluetooth devices can communicate without wires, using frequency-hopping spread spectrum (FHSS) radio frequency (RF) to transmit and receive data in the 2.4 GHz Industry Scientific and Medical (ISM) band (802.15.1). Bluetooth wireless technology is specifically designed for short-range (10 m (32.8 ft)) communication and low power consumption.

Devices with Bluetooth capabilities can exchange information (for example, files, appointments, and tasks) with other Bluetooth enabled devices such as printers, access points, and other mobile devices.

The device supports Bluetooth Low Energy. Bluetooth Low Energy is targeted at applications in the healthcare, fitness, security, and home entertainment industries. It provides reduced power consumption and cost while maintaining standard Bluetooth range.

## Adaptive Frequency Hopping

Adaptive Frequency Hopping (AFH) is a method of avoiding fixed frequency interferers, and can be used with Bluetooth voice. All devices in the piconet (Bluetooth network) must be AFH-capable in order for AFH to work. There is no AFH when connecting and discovering devices. Avoid making Bluetooth connections and discoveries during critical 802.11b communications. AFH for Bluetooth consists of four main sections:

- **Channel Classification** - A method of detecting an interference on a channel-by-channel basis, or pre-defined channel mask.
- **Link Management** - Coordinates and distributes the AFH information to the rest of the Bluetooth network.
- **Hop Sequence Modification** - Avoids interference by selectively reducing the number of hopping channels.
- **Channel Maintenance** - A method for periodically re-evaluating the channels.

When AFH is enabled, the Bluetooth radio “hops around” (instead of through) the 802.11b high-rate channels. AFH coexistence allows enterprise devices to operate in any infrastructure.

The Bluetooth radio in this device operates as a Class 2 device power class. The maximum output power is 2.5 mW and the expected range is 10 m (32.8 ft). A definition of ranges based on power class is difficult to obtain due to power and device differences, and whether in open space or closed office space.



**NOTE:** It is not recommended to perform Bluetooth wireless technology inquiry when high rate 802.11b operation is required.

## Security

The current Bluetooth specification defines security at the link level. Application-level security is not specified. This allows application developers to define security mechanisms tailored to their specific need. Link-level security occurs between devices, not users, while application-level security can be implemented on a per-user basis. The Bluetooth specification defines security algorithms and procedures required to authenticate

devices, and if needed, encrypt the data flowing on the link between the devices. Device authentication is a mandatory feature of Bluetooth while link encryption is optional.

Pairing of Bluetooth devices is accomplished by creating an initialization key used to authenticate the devices and create a link key for them. Entering a common personal identification number (PIN) in the devices being paired generates the initialization key. The PIN is never sent over the air. By default, the Bluetooth stack responds with no key when a key is requested (it is up to user to respond to the key request event). Authentication of Bluetooth devices is based-upon a challenge-response transaction. Bluetooth allows for a PIN or passkey used to create other 128-bit keys used for security and encryption. The encryption key is derived from the link key used to authenticate the pairing devices. Also worthy of note is the limited range and fast frequency hopping of the Bluetooth radios that makes long-distance eavesdropping difficult.

Recommendations are:

- Perform pairing in a secure environment
- Keep PIN codes private and do not store the PIN codes in the device
- Implement application-level security.

## Bluetooth Profiles

The device supports the Bluetooth services listed in the table below:

Table 17 Bluetooth Profiles

Profile	Description
Service Discovery Protocol (SDP)	Handles the search for known and specific services as well as general services.
Serial Port Profile (SPP)	Allows use of RFCOMM protocol to emulate serial cable connection between two Bluetooth peer devices. For example, connecting the device to a printer.
Object Push Profile (OPP)	Allows the device to push and pull objects to and from a push server.
Human Interface Device Profile (HID)	Allows Bluetooth keyboards, pointing devices, gaming devices and remote monitoring devices to connect to the device.
Out of Band (OOB)	Allows exchange of information used in the pairing process. Pairing is completed using the Bluetooth radio, but requires information from the OOB mechanism. Using OOB with NFC enables pairing when devices simply get close, rather than requiring a lengthy discovery process.
Generic Attribute Profile (GATT)	Provides profile discovery and description services for Bluetooth Low Energy protocol. It defines how attributes are grouped together into sets to form services.
Generic Access Profile (GAP)	Use for device discovery and authentication.
OBject EXchange (OBEX)	Facilitates the exchange of binary objects between devices.

## Bluetooth Power States

The Bluetooth radio is off by default:

- Suspend - When the device goes into suspend mode, the Bluetooth radio stays on.

- Airplane Mode - When the device is placed in Airplane Mode, the Bluetooth radio turns off. When Airplane mode is disabled, the Bluetooth radio returns to the prior state. When in Airplane Mode, the Bluetooth radio can be turned back on if desired.

## Bluetooth Radio Power

Turn off the Bluetooth radio to save power or if entering an area with radio restrictions (for example, an airplane). When the radio is off, other Bluetooth devices cannot see or connect to the device. Turn on the Bluetooth radio to exchange information with other Bluetooth devices (within range). Communicate only with Bluetooth radios in close proximity.



**NOTE:** To achieve the best battery life, turn off radios when not in use.

### Enabling Bluetooth

To enable Bluetooth:

1. Go to **Settings**.
2. Touch  to turn Bluetooth on.
3. Touch .

### Disabling Bluetooth

To disable Bluetooth:

1. Go to **Settings**.
2. Touch  to turn Bluetooth off.
3. Touch .

## Discovering Bluetooth Device(s)

The device can receive information from discovered devices without pairing. However, once paired, the device and a paired device exchange information automatically when the Bluetooth radio is on. To find Bluetooth devices in the area:

1. Ensure that Bluetooth is enabled on both devices.
2. Ensure that the Bluetooth device to discover is in discoverable mode.
3. Ensure that the two devices are within 10 meters (32.8 feet) of one another.
4. Swipe down from the Status bar to open the Quick Access panel.
5. Touch and hold **Bluetooth**.
6. Touch **Pair new device**. The device begins searching for discoverable Bluetooth devices in the area and displays them under **Available devices**.
7. Scroll through the list and select a device. The Bluetooth pairing request dialog box appears.
8. Touch **Pair** on both devices.
9. The Bluetooth device is added to the **Paired devices** list and a trusted (“paired”) connection is established.



## Changing the Bluetooth Name

By default, the device has a generic Bluetooth name that is visible to other devices when connected.

1. Go to **Settings**.
2. Touch **Connected devices > Connection preferences > Bluetooth**.
3. If Bluetooth is not on, move the switch to turn Bluetooth on.
4. Touch **Device name**.
5. Enter a name and touch **RENAME**.
6. Touch .

## Connecting to a Bluetooth Device

Once paired, connect to a Bluetooth device.

1. Go to **Settings**.
2. Touch **Connected devices > Connection preferences > Bluetooth**.
3. In the list, touch the unconnected Bluetooth device.  
When connected, **Connected** appears below the device name.

## Selecting Profiles on the Bluetooth Device

Some Bluetooth devices have multiple profiles. To select a profile:

1. Go to **Settings**.
2. Touch **Connected devices > Connection preferences > Bluetooth**.
3. In the **Paired Devices** list, touch  next to the device name.
4. Turn on or off a profile to allow the device to use that profile.
5. Touch .

## Unpairing a Bluetooth Device

To unpair a Bluetooth device and erase all pairing information:

1. Go to **Settings**.
2. Touch **Connected devices > Connection preferences > Bluetooth**.
3. In the **Paired Devices** list, touch  next to the device name.
4. Touch **FORGET**.
5. Touch .

## Cast

Use **Cast** to mirror the device screen on a Miracast enabled wireless display.

1. Go to **Settings**.
2. Touch **Connected devices > Connection preferences > Cast**.
3. Touch **⋮ > Enable wireless display**. The device searches for nearby Miracast devices and lists them.
4. Touch a device to begin casting.
5. Touch **○**.

# Accessories

A typical Personal Shopper system is comprised of a family of hardware devices interconnected through a WLAN radio backbone to the retail establishment's server(s). The hardware devices are the PS20 personal shoppers, single slot or three slot cradles, power supplies and cables. A dispenser typically refers to a piece of furniture which has mounted to it the cradles, their power supplies, and cables.

Customers (retail establishments) design their own dispensers to meet their particular floor space and display requirements. The information in this chapter should help a customer to design a dispenser and to understand the installation requirements.



**IMPORTANT:** The MC18 cradles are compatible with the PS20.

## Accessories

Table 18 Accessories

Accessory	Part Number	Description
PS20 Lithium Ion Battery	BTRY-PS20-35MA-01	PS20 PowerPrecision+ Lithium Ion Battery.
	BTRY-PS20-35MA-10	PS20 PowerPrecision+ Lithium Ion Battery (QTY-10).
High Density (HD) Three Slot Cradle (Locking).	CRD-MC18-3SLCKH-01	The cradle is used for docking up to three PS20 units in HD installation configuration. The cradle slots are equipped with a mechanism that locks the PS20 units inside the slots. The devices are placed with the display facing to the front. Requires power supply unit (PWR-BGA12V108W0WW), DC line cord and country specific AC line cord (sold separately).
High Density (HD) Three Slot Cradle (Non-Locking)	CRD-MC18-3SLOTH-01	The cradle is used for docking up to three PS20 units in HD installation configuration. The devices are placed with the display facing to the front. Requires power supply unit (PWR-BGA12V108W0WW), DC line cord and country specific AC line cord (sold separately).

## Accessories

Table 18 Accessories (Continued)

Accessory	Part Number	Description
Super High Density (SHD) Three Slot Cradle (Locking)	CRD-MC18-3SLCKS-01	The cradle is used for docking up to three PS20 units in SHD installation configuration. The cradle slots are equipped with a mechanism that locks the PS20 units inside the slots. The devices are placed with the display facing up. Requires power supply unit (PWR-BGA12V108W0WW), DC line cord and country specific AC line cord (sold separately).
Single Slot Cradle	CRD-MC18-1SLOT-01	The cradle is used for docking a single PS20. The devices are placed with the display facing to the front. Requires power supply unit (PWR-BGA12V108W0WW), DC line cord and country specific AC line cord (sold separately).
Release Key	KT-MC18-CKEY-20	Tool used to mechanically unlock the PS20 from the Three Slot Cradle and the Single Slot Cradle (QTY-20).
Terminal Reboot Tool	KT-MC18-REBOOT-05	Tool used to perform cold boot of the PS20 (QTY-5).
Cradle Cover Removal Tool	KT-MC18-CTOOL-01	Tool used for removing the Three Slot Cradle cover.
Deployment Kit	KT-MC18-CSTKIT-01	PS20 Deployment Starter Kit. Includes: 20-pack of Release Key (KT-MC18-CKEY-20) 5-pack of Terminal Reboot Tool (KT-MC18-REBOOT-05) One Three Slot Cradle Cover Removal Tool (KT-MC18-CTOOL-01)
Cart Holder Mounting Kit	PSS-3SH01-00R	Kit for mounting the PS20 on a shopping cart.
Soft Holster	SG-PS20-SFTHLT-01	Allows for wearing the PS20 on the hip (includes belt clip) or crossbody, with an additional shoulder strap.
Tempered Glass Screen Protector	MISC-PS20-SCRN-05	Provides additional protection for PS20 display (5-pack).
Programming Cable	CBL-PS20-USBCHG-01	PS20 USB communication cable for connecting the device to a host computer.
Interconnection Cable Long	25-66430-01R	PS20 cradle interconnection cable (60 Inch / 1.5 Meter). Connects cradles to each other to run off one power supply unit (PWR-BGA12V108W0WW).
Interconnection Cable Short	25-66431-01R	PS20 cradle interconnection cable (12.6 Inch / 32 centimeter). Connects cradles to each other to run off one power supply unit (PWR-BGA12V108W0WW).

## Accessories

Table 18 Accessories (Continued)

Accessory	Part Number	Description
Cradle Interconnection Extension Cable	CBL-MC18-EXINT1-01	PS20 cradle interconnection extension cable (12.6 Inch / 32 centimeter). Connects two interconnection cables (25-66431-01R sold separately) together to provide additional length which might be required in some installation designs.
DC Charging Cable	CBL-DC-394A1-01	DC charging cable (19.5 Inch / .5 Meter) used to connect a power supply unit (PWR-BGA12V108W0WW) to one Single Slot Cradle.
DC "Y" Charging Cable Long	CBL-DC-392A1-02	DC "Y" charging cable (79.4 Inch / 2 Meter). Connects a power supply unit (PWR-BGA12V108W0WW) to two separate Three Slot Cradles.
DC "Y" Charging Cable Short	CBL-DC-393A1-02	DC "Y" charging cable (39.7 Inch / 1 Meter). Connects a power supply unit (PWR-BGA12V108W0WW) to two separate Three Slot Cradles.
Power Supply Unit	PWR-BGA12V108W0WW	100-240VAC, 12VDC, 9A. Requires country specific AC line cord and DC cable (sold separately).
AC Line Cord	23844-00-00R	AC Line Cord, 7.5 feet long, grounded, three wire for power supplies. Associated Country: United States
AC Line Cord	50-16000-221R	AC Line Cord, 1.8 meter, meter grounded, three wire, USA NEMA 5-15P. Associated Country: United States
AC Line Cord	50-16000-671R	AC Line Cord, 1.8 meter, grounded, three wire, CIE 23-16 plug. Associated Country: Italy.
AC Line Cord	50-16000-217R	AC Line Cord, 1.9 meter, grounded, three wire, AS 3112 plug. Associated Countries: Australia, New Guinea
AC Line Cord	50-16000-218R	AC Line Cord, 1.8 meter, grounded, three wire, NEMA 1-15P plug. Associated Country: Japan.
AC Line Cord	50-16000-219R	AC Line Cord, 1.8 meter, grounded three wire, BS1363 plug. Associated countries: Hong Kong, Iraq, Malaysia, Singapore, United Kingdom.
AC Line Cord	50-16000-220R	AC Line Cord, 1.8 meter, grounded three wire CEE 7/7plug. Associated countries: Europe, Abu Dhabi, Bolivia, Dubai, Egypt, Iran, Russia, Vietnam.
AC Line Cord	50-16000-257R	AC Line Cord, 1.8 meter, grounded three wire, IEC 60320 C13 plug. Associated Country: China.

Table 18 Accessories (Continued)

Accessory	Part Number	Description
AC Line Cord	50-16000-669R	1.9 meter grounded three wire, BS 546 Plug. Associated country: India.
AC Line Cord	50-16000-672R	1.9 meter grounded three wire, S132 Plug. Associated country: Israel.
AC Line Cord	50-16000-678R	36 inch grounded three wire. Associated country: United States

## Installation of the Single Slot Cradle

Installation of the Single Slot Cradle include the following mounting steps:

- Select the charging mode (see Charging Modes on page 98)
- Mount the Single Slot Cradles on a dispenser wall (see Mounting the Single Slot Cradle on a Dispenser Wall on page 98)
- Connect the wires to the cables (see Wiring on page 101)
- Set the cradle(s) (see Controlling the Cradle on page 110)

## Charging Modes

Single Slot Cradles can be installed in the following charging modes:

- Standard charging
- Fast charging

There are some general charging considerations that must be taken into account when designing a dispenser and ordering hardware elements of a system:

### Standard Charging Mode

- In standard charging mode, no more than 12 cradles can be powered off of one power supply unit (p/n PWR-BGA12V108W0WW) using “Y” power cable CBL-DC-392A1-02.
- In standard charging mode, the current draw by each docked PS20 can reach a maximum of 1A.

### Fast Charging Mode

- In fast charging mode, no more than six cradles can be powered off of one power supply unit (p/n PWR-BGA12V108W0WW) using power cable CBL-DC-394A1-01.
- In fast charging mode, the current draw by each docked PS20 can reach a maximum of 1.5A.

## Mounting the Single Slot Cradle on a Dispenser Wall

The cradle contains two mounting holes in the back housing so that it can be hanged on screws fixed to a supporting furniture. In addition, it comes with plugs and a variety of cable routing outlets. Figure 57 on page 100 provides the necessary information about the location and dimensions of the mounting holes of the cradle.

To mount the Single Slot Cradle:

1. Loosen two captive screws securing the front cover to the base.

Figure 55 Remove Screws

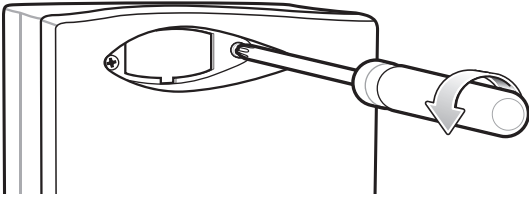

2. Pull front cover away from base and then lift out of the base.

Figure 56 Cover Removal

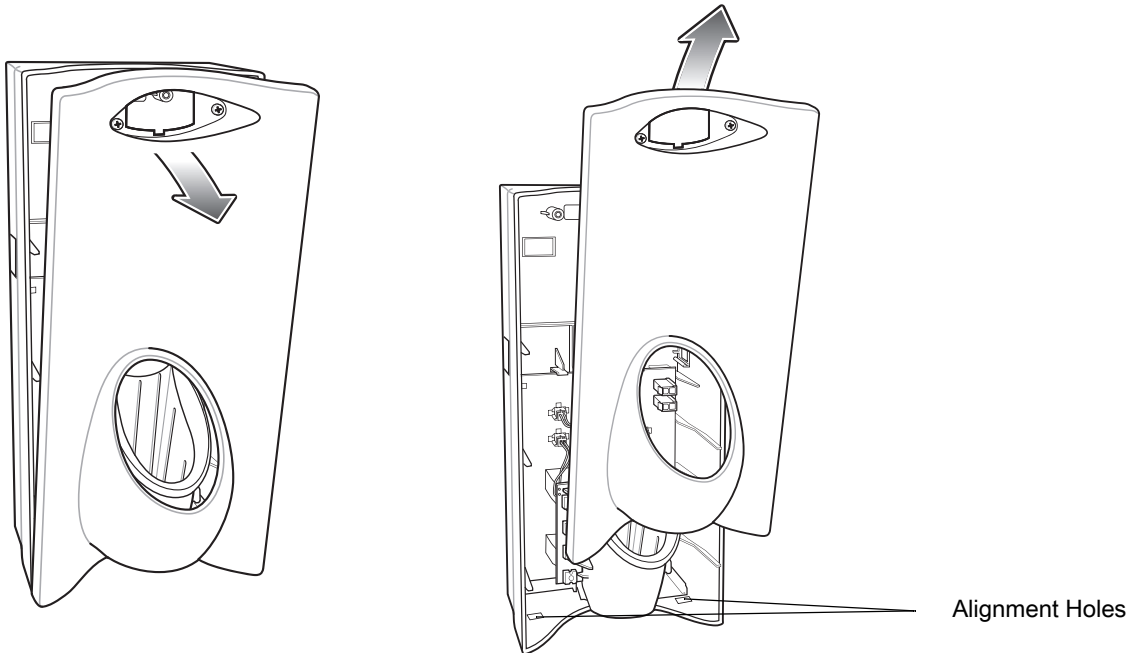

3. Use two screws to hang the cradle on a wall.

Figure 57 Hanging the Cradle on a Wall - Mounting Template

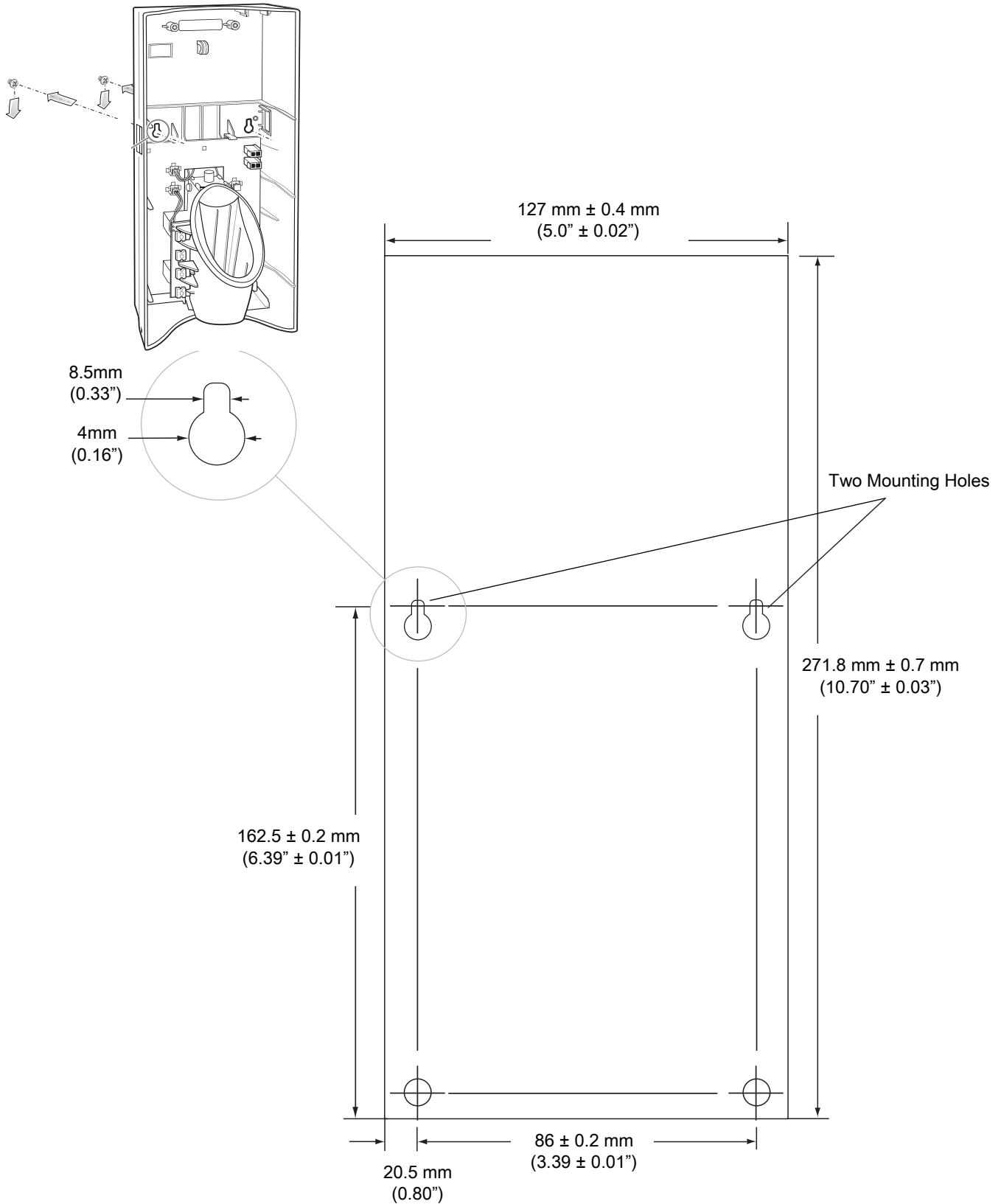
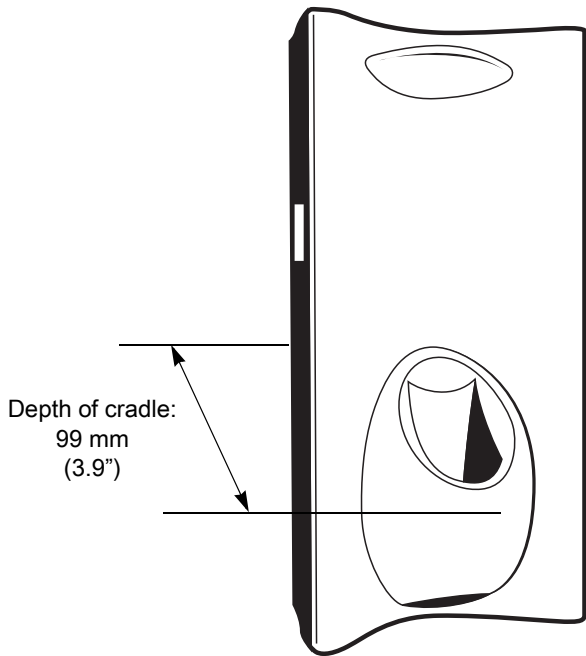



Figure 58 Overall Depth of Cradle



## Wiring



**NOTE:** During installation, ensure all interconnect cables are fully enclosed within the power supply or cradle enclosure.

1. Install power supply, including AC line cord and power cable, into Decorative Housing.

Figure 59 Connecting Power Supply

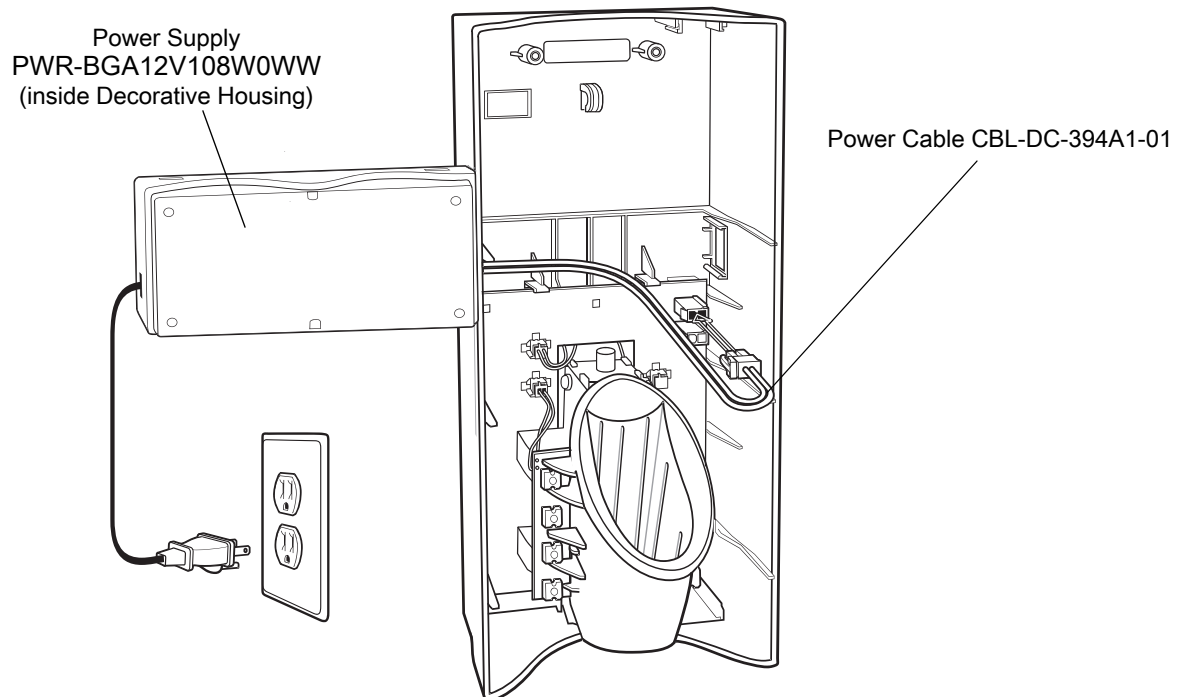

2. Insert power cable through a cable outlet of cradle back housing.
3. Plug connector into power connector on printed circuit board.
4. If more than one cradle is being installed, connect the interconnect cable from the first cradle to the second cradle.

Figure 60 Daisy-Chaining Cradles

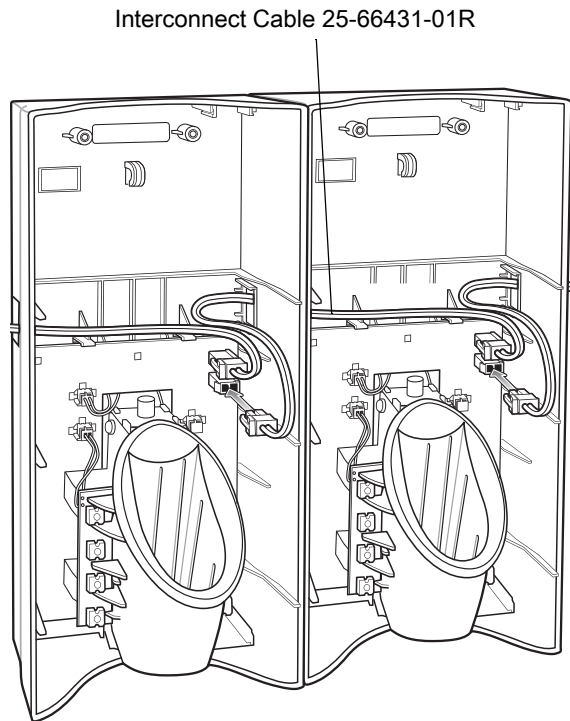

5. Use plugs to cover un-used cable outlets.

Figure 61 Cable Hole Plug Installation

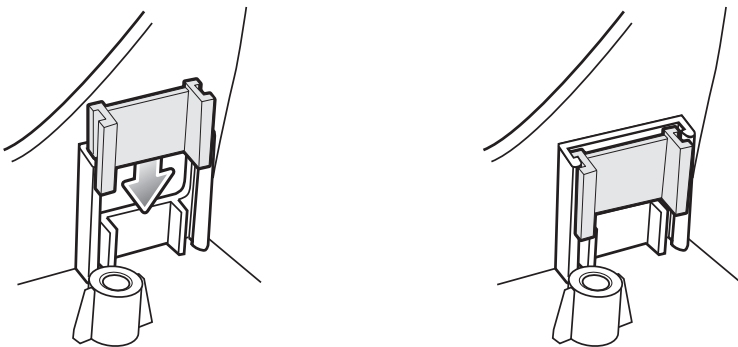

## Assembly

1. Replace cover.
2. Secure cover with screws.

Figure 62 Replace Cover

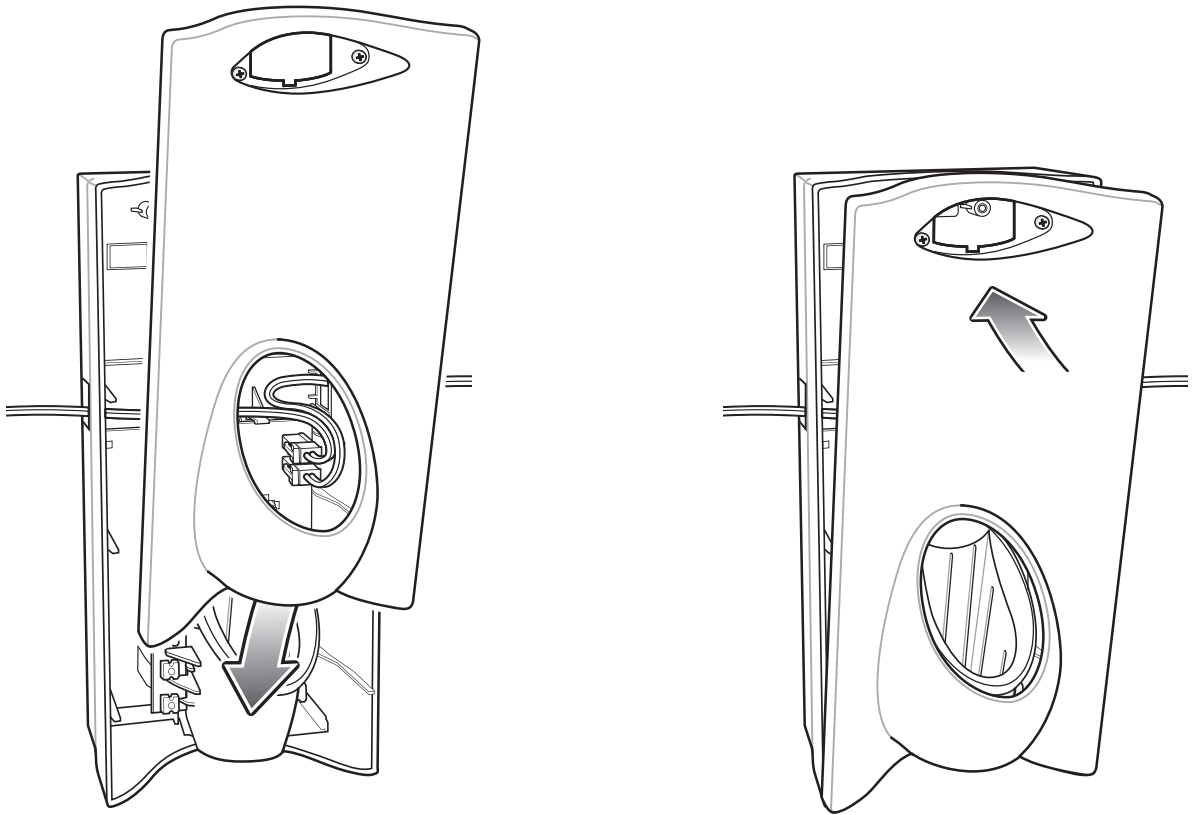

**NOTE:** Do not install the target cover until you are sure that you do not need to remove the front cover again.

3. Insert bar code target cover.
4. Push target cover into front cover until it snaps into place.

Figure 63 Replace Target Bar Code Cover

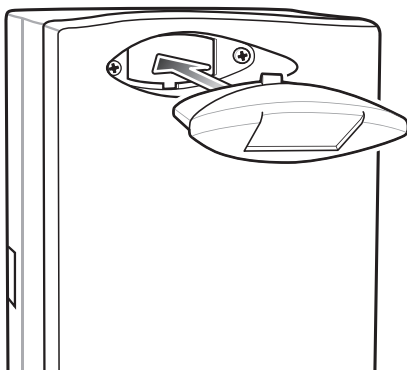

## System Cabling

There are some general limitations that must be taken into account when designing a dispenser and ordering hardware elements of a Personal Shopper system:

- No more than six cradles can be powered off each leg of the “Y” power cable.
- A power supply cable runs from the power supply to one or two cradles.

- Cradle interconnection cables run between each successive cradle in the chain.
- The power supply is air cooled, and as such expects some circulation of fresh air around it. Do not enclose it in a small airtight location.
- Power supplies must be mounted in their natural, landscape orientation. They contain fans and their vents must allow for the free flow of air.
- Power supplies should be mounted either above or below dispensers and entrance heads. Mounting of power supplies to the right or left is not preferred.
- When laying out your furniture and cabling plan, routing should be as direct as possible. Routing should follow vertical and horizontal runs through the modules. A set of labels, numbered 1 to 12, is part of each power supply unit. These labels are to be used to track the number of loads on a particular supply. Each label is designed to be attached to the cradle interconnection cable when a cradle is added to the daisy chain. When all labels are used, the supply is fully loaded.

Figure 64 on page 104 shows how the maximum number of cradles can be cabled to a power supply using power cable CBL-DC-394A1-01.

Figure 65 on page 105 shows how the maximum number of cradles can be cabled to a power supply using the “Y” power cable CBL-DC-392A1-02. Note that there are only six cradles per leg of the power supply cable, and only 12 cradles in total.

Figure 64 Maximum Number of Charge Cradles per Power Supply

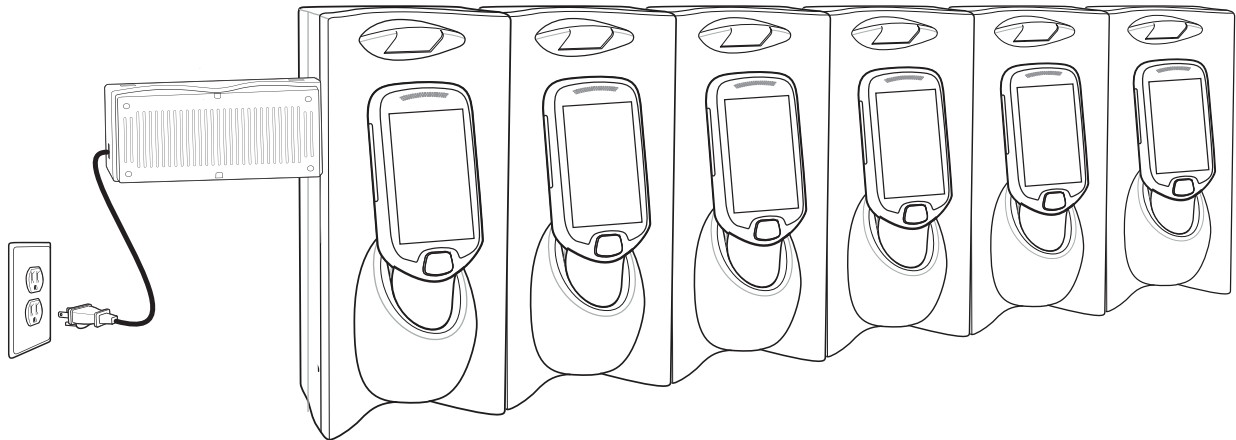
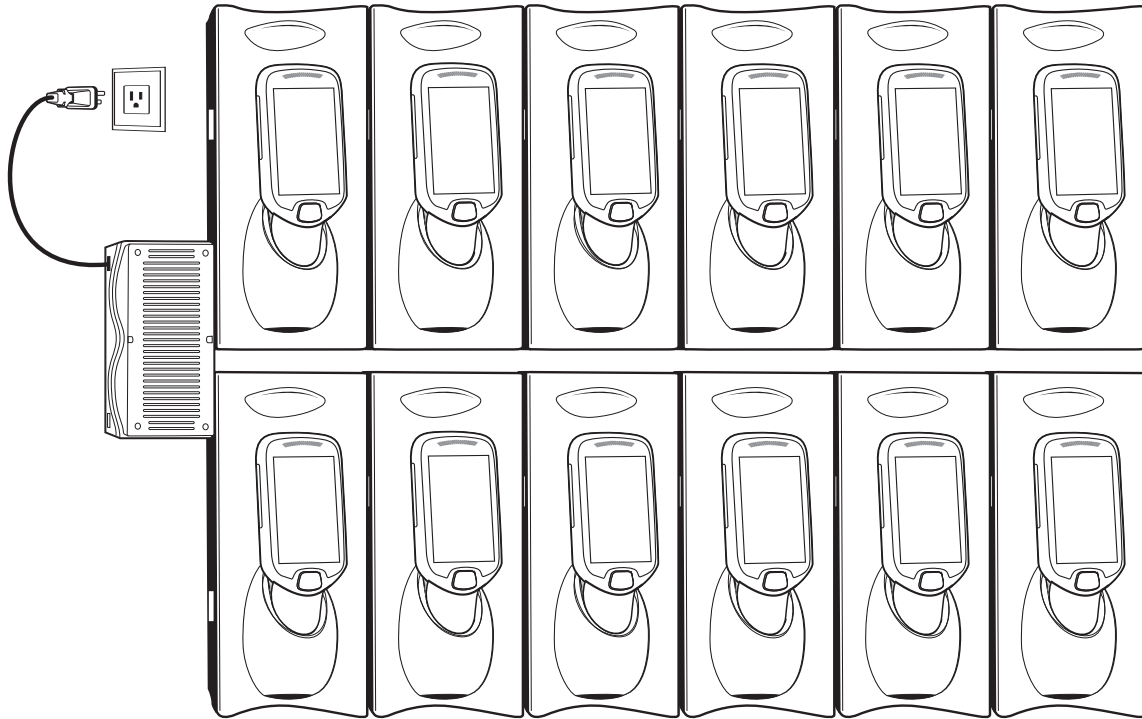

Figure 65 Maximum Number of Charge Cradles per Power Supply with “Y” Power Cable



## Installation of the Three Slot Cradle

Installation of the Three Slot Cradle include the following mounting steps:

- Select the mounting configuration (see Mounting Configurations on page 105)
- Select the charging mode (see Charging Modes on page 107)
- Mount the Three Slot Cradles on a dispenser wall (see Mounting the Three Slot Cradle on a Dispenser Wall on page 109)
- Set the cradle(s) (see Controlling the Cradle on page 110)

## Mounting Configurations

Three slot cradles can be installed in the following mounting configurations:

- High Density (HD) configuration - Using HD cradles
- Super High Density (SHD) configuration - Using SHD cradles
- Desktop configuration - Using stand alone cradle(s) on a flat surface

### High Density Configuration

The cradle can be installed in high density configuration so that the display of the PS20 devices are facing the user. In this configuration, cradles are installed with a vertical gap of 35mm between each other.



**NOTE:** In high density configuration, the PS20 units have a 10-degree forward-facing tilt that should be taken in consideration, especially if furniture is planned to be placed in front of the dispenser wall.

Figure 66 Installation in High Density Configuration

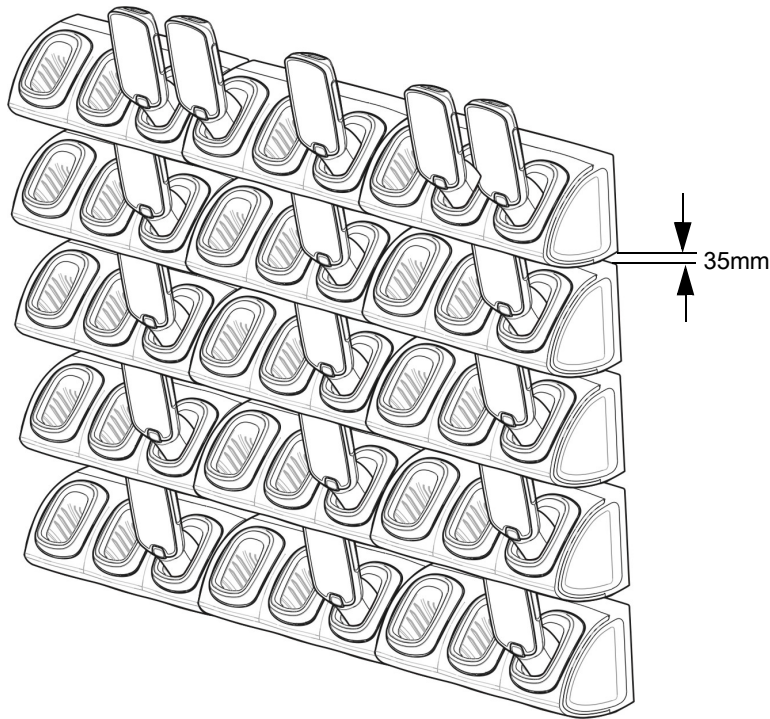

The installation of the dispenser wall can be designed so that it tilts slightly backward in the following angles:

Figure 67 Dispenser Wall Angles

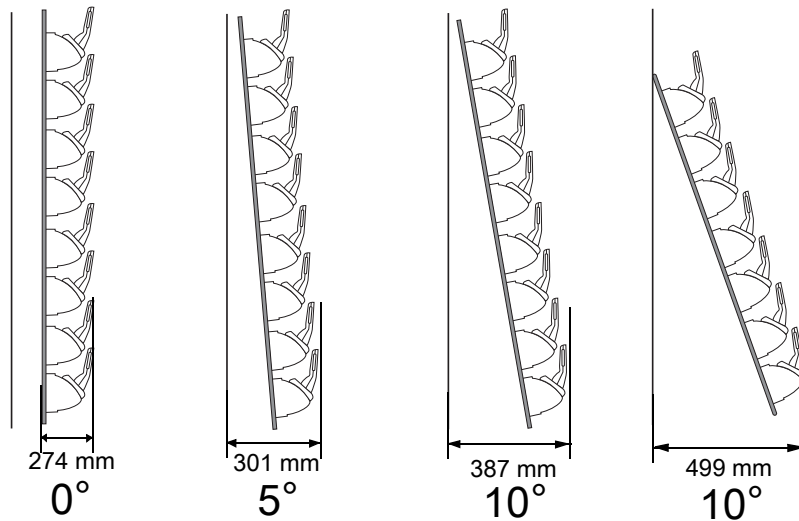

### Super High Density Configuration

The cradle can be installed in super high density configuration so that the display of the PS20 devices are facing up. In such configuration, cradles are installed with a vertical gap of 7mm from each other to allow more cradles per square meter.

Figure 68 Installation in Super High Density Configuration

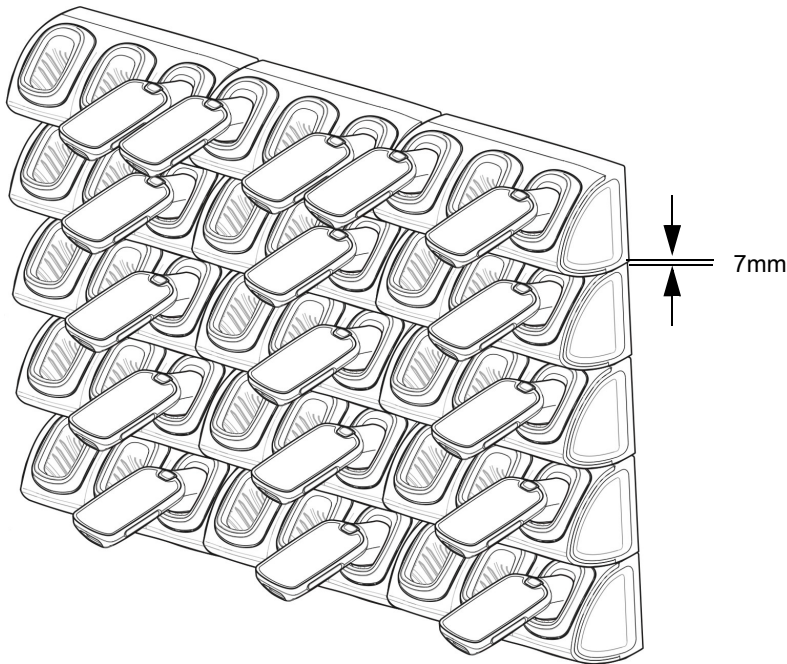

## Desktop Configuration

In desktop configuration, the cradle can be placed on a flat tabletop or shelf at checkout or back room locations.

Figure 69 Installation in Desktop Configuration

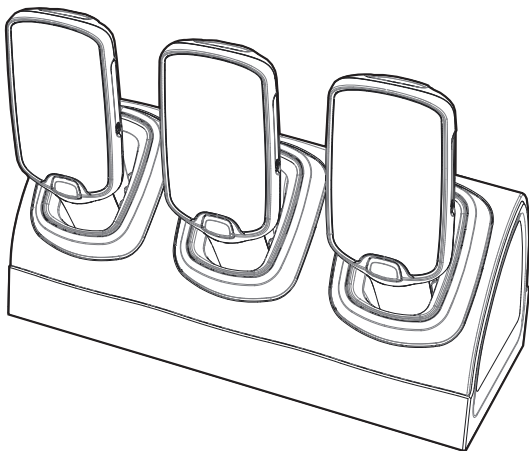

## Charging Modes

Three Slot Cradles can be installed in the following charging modes:

- Standard charging
- Fast charging

There are some general charging considerations that must be taken into account when designing a dispenser and ordering hardware elements of a system:



## Standard Charging Mode

- In standard charging mode, no more than four cradles can be powered off of one power supply unit (p/n PWR-BGA12V108W0WW) using “Y” power cable (p/n CBL-DC-392A1-02 or p/n CBL-DC-393A1-02), power extension cables (p/n CBL-MC18-EXINT1-01) and interconnect cables (p/n 25-66431-01R).
- In standard charging mode, the current draw by each docked PS20 can reach a maximum of 1A.
- Cable routing should be as direct as possible. Routing should follow vertical and horizontal runs through the modules.

Figure on page 108 shows how the four cradles can be cabled to a power supply unit in standard charging mode.

Figure 70 Standard Charging Mode - Cable Connections

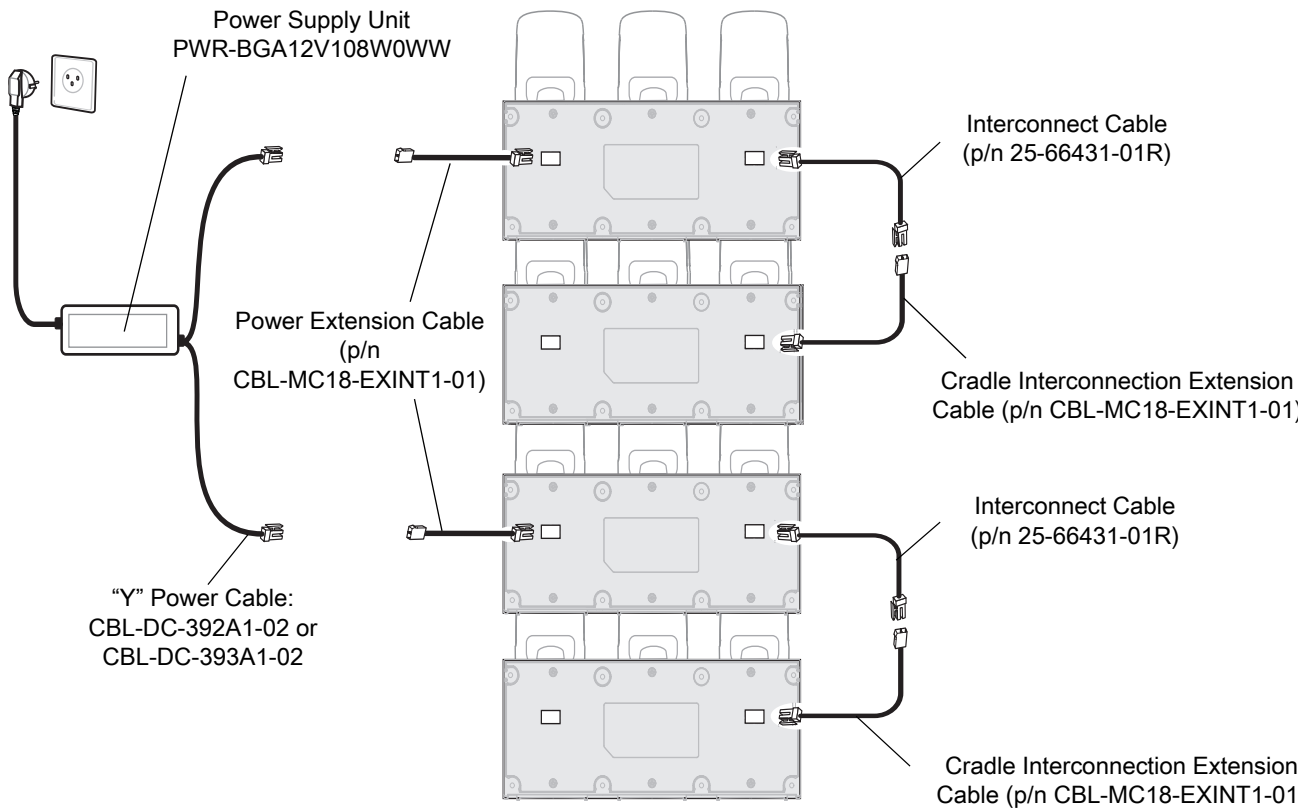

## Fast Charging Mode

- In fast charging mode, no more than three cradles can be powered off of one power supply unit (p/n PWR-BGA12V108W0WW) using “Y” power cable (p/n CBL-DC-392A1-02 or p/n CBL-DC-393A1-02), Interconnect cables (p/n 25-66431-01R) and cradle interconnection extension cables (p/n CBL-MC18-EXINT1-01).
- In fast charging mode, the current draw by each docked PS20 can reach a maximum of 1.5A.
- Cable routing should be as direct as possible. Routing should follow vertical and horizontal runs through the modules.

Figure on page 109 shows how the three cradles can be cabled to a power supply unit in fast charging mode.



Figure 71 Fast Charging Mode Cable Connections

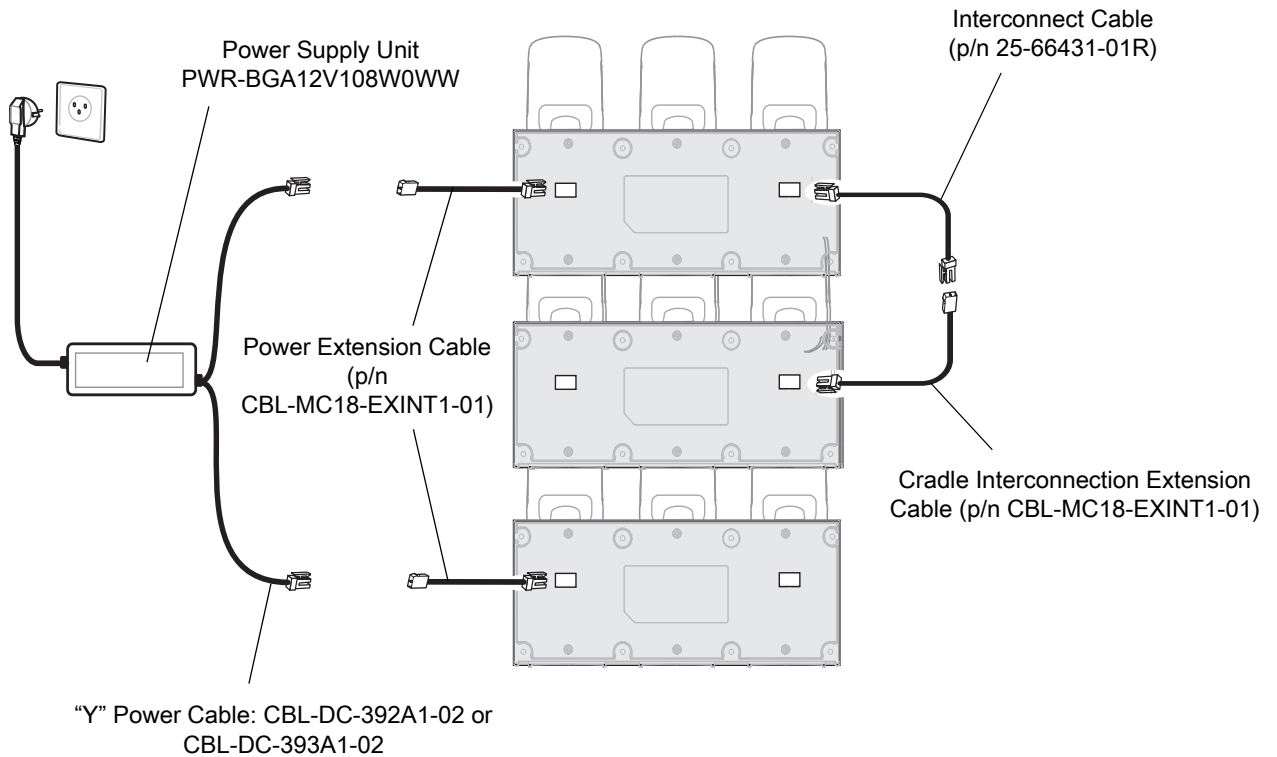

## Mounting the Three Slot Cradle on a Dispenser Wall

The cradle can be bolted to a dispenser wall or any supporting furniture using eight mounting holes. The back cover of the cradle has two access holes for routing power cables to \ from a power supply unit or adjacent cradle. Figure on page 110 provides a mounting template for cradle installation.

Perform this procedure to mount the cradle on a dispenser wall:



**CAUTION:** DO NOT connect more than four cradles when is standard charging mode or three cradles when in fast charging mode to a single power supply unit.  
DO NOT connect the power supply unit to a power outlet until all installation steps are completed.



**NOTE:** The following procedure is an example installation of Three Slot Cradles in fast charging mode - high density configuration.

1. Use the wall mount template to plan and mark the screw locations on the dispenser wall.

Figure 72 Three Slot Cradle - Mounting Template and Overall Depth

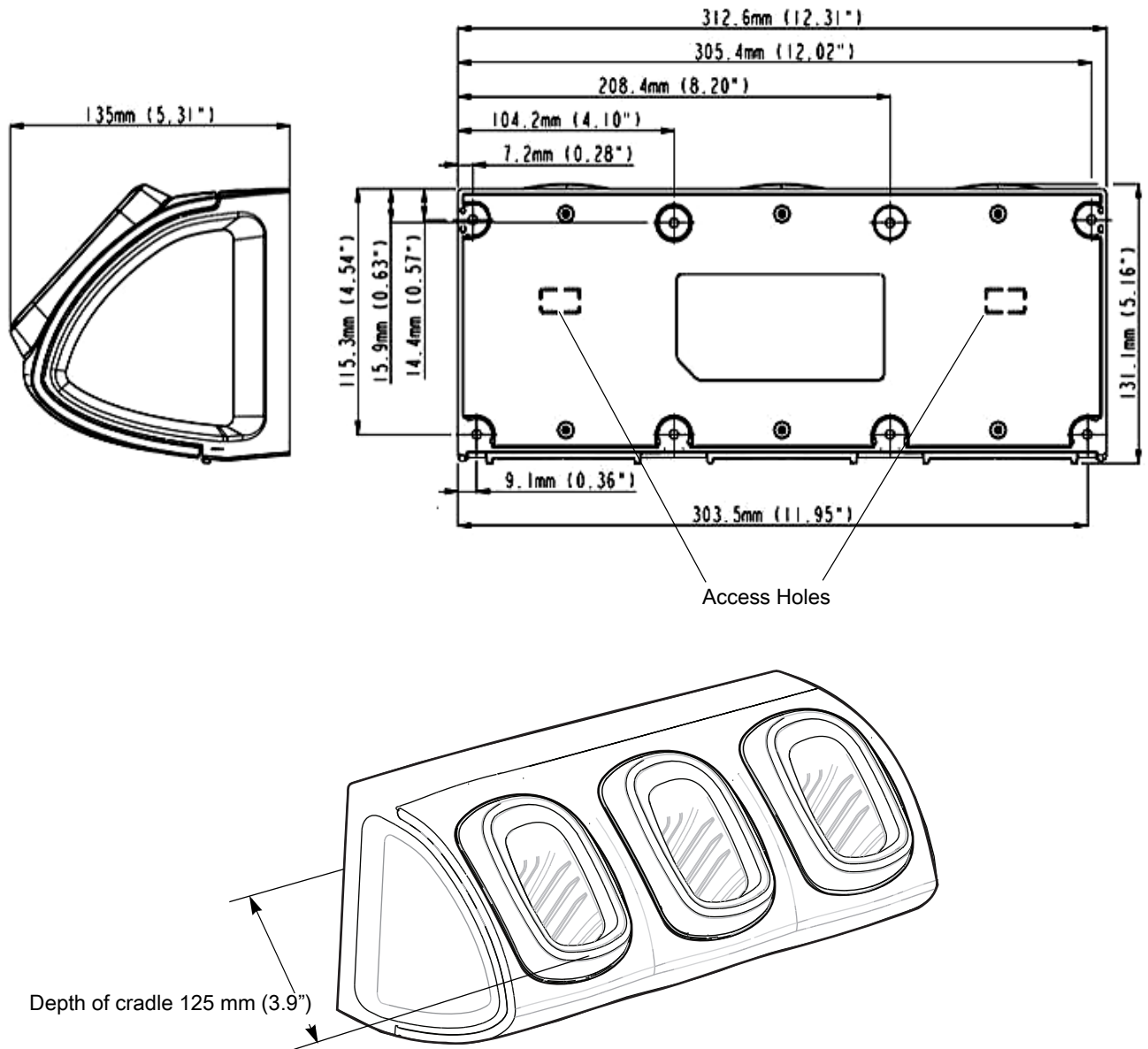

2. In all cradles, plug the power extension cable (p/n CBL-MC18-EXINT1-01) to free the connector on left slot.
3. Plug interconnect cable (p/n 25-66431-01R) to free connector on right slot.

Figure 73 Three Slot Cradle - Cable Connections

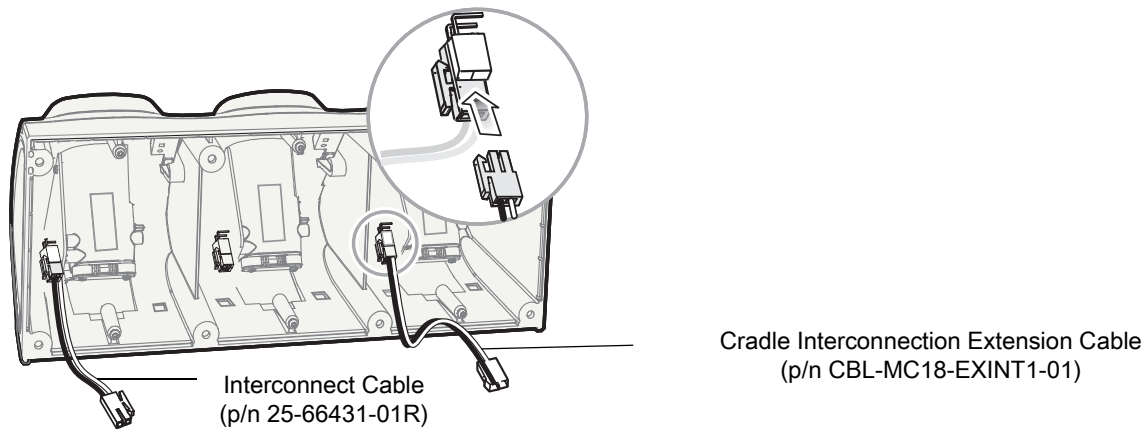

4. On all the back covers, knock-out the stamped access hole(s).

Figure 74 Three Slot Cradle - Stamped Access Hole(s)

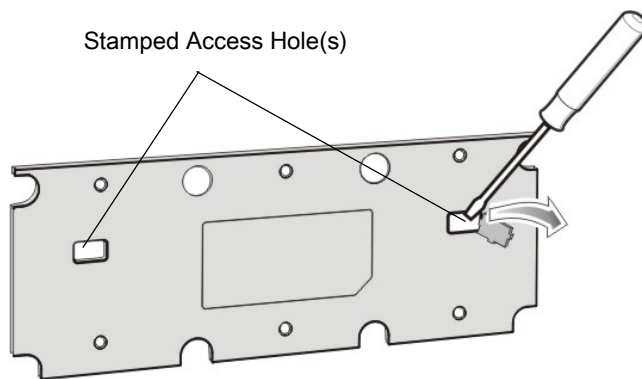

5. Route interconnect cables through access holes in back covers.

Figure 75 Three Slot Cradle - Back Cover Cable Routes

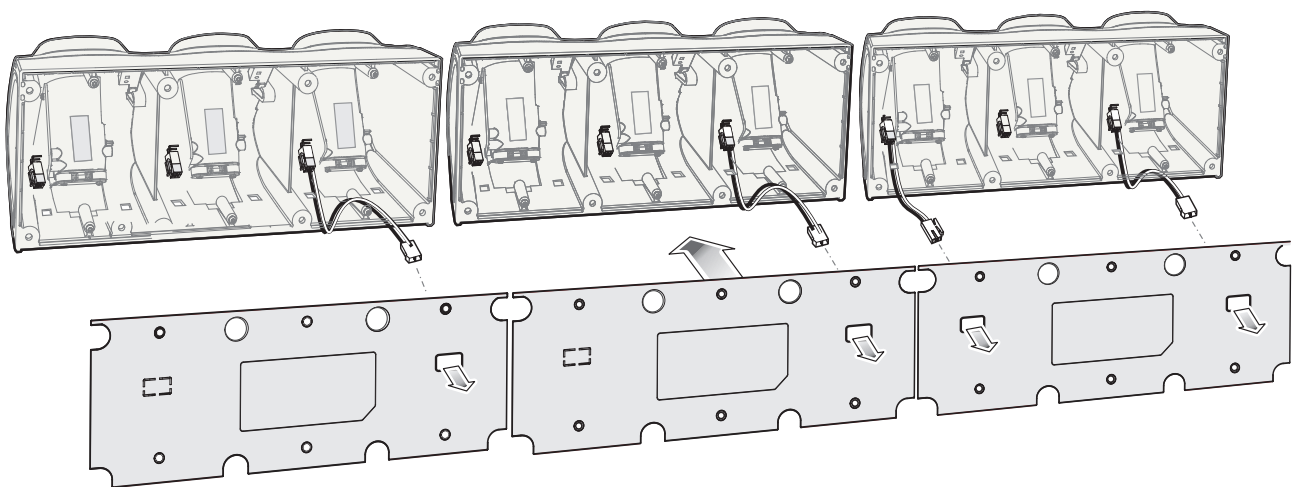

6. Secure the back cover of each cradle using six T10 Torx screws (supplied). Torque screws to 6 Kgf-cm (5.2 in-lb).

Figure 76 Three Slot Cradle - Securing the Back Cover

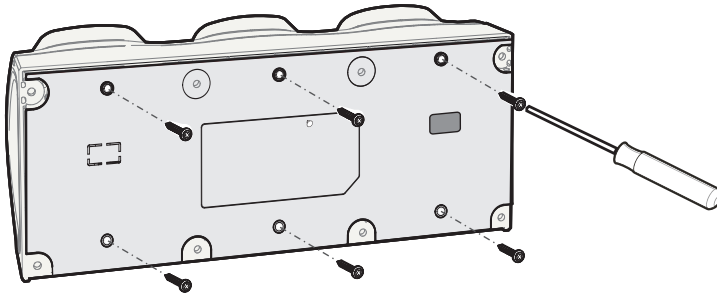

7. Insert the front cover removal tool into two slots, lever upwards and pull to remove front cover from cradle.

Figure 77 Three Slot Cradle - Removing Front Cover

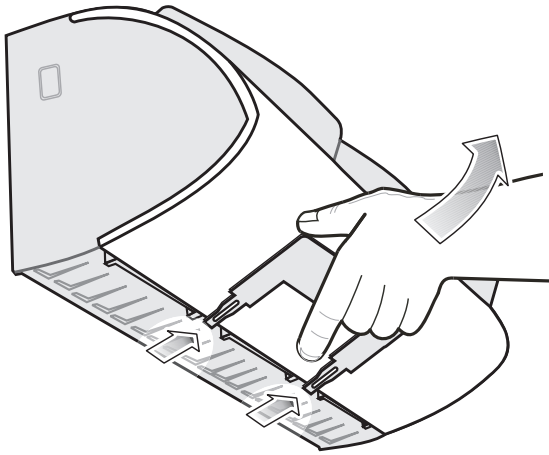

8. Position the cradle on the dispenser wall and route all interconnect cables through the access holes in the dispenser wall.
9. Fasten the cradle to the wall using eight screws (not supplied). Make sure to use additional wall mounting hardware, as needed, for safe mounting, according to the wall type.

Figure 78 Three Slot Cradle - Fastening the Cradle to a Wall

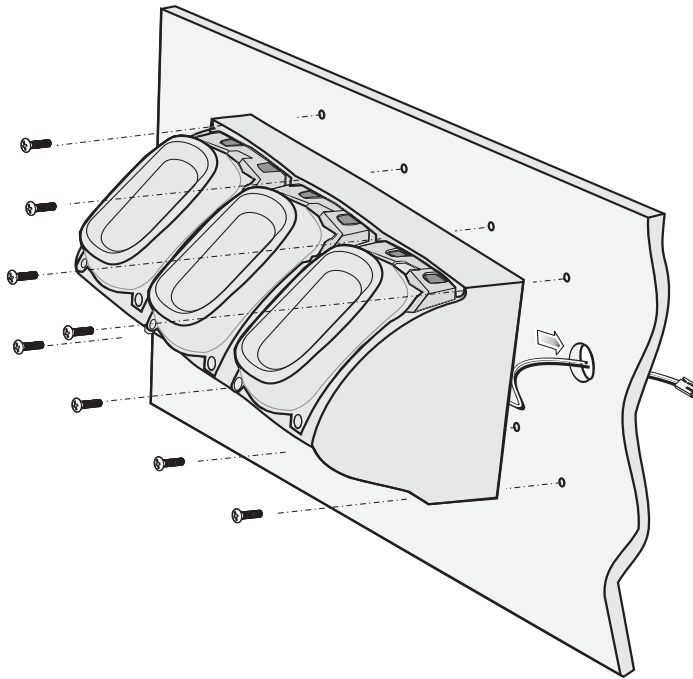

10. Insert tabs on upper side of front cover into slots on cradle and rotate cover down until it snaps into place.

Figure 79 Three Slot Cradle - Connecting the Front Cover

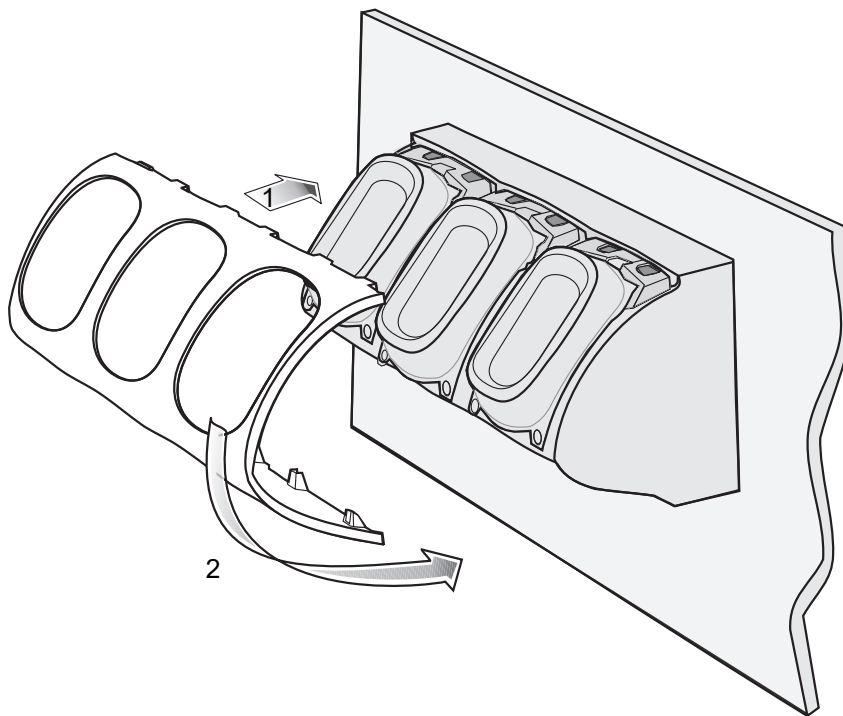

11. Plug Power Extension Cable (p/n CBL-MC18-EXINT1-01) to interconnect cable (p/n 25-66431-01R).

12. Plug "Y" cable (CBL-DC-392A1-02) to Interconnect cables (p/n 25-66431-01R).

13. Plug "Y" cable (CBL-DC-392A1-02) to power supply unit.

14. Secure power supply unit (p/n PWR-BGA12V108W0WW) to the back of the dispenser wall.

15. Connect the power cord to the power supply unit and to a 110/220 VAC outlet.

Figure 80 Three Slot Cradle - Connection to Power Supply Unit

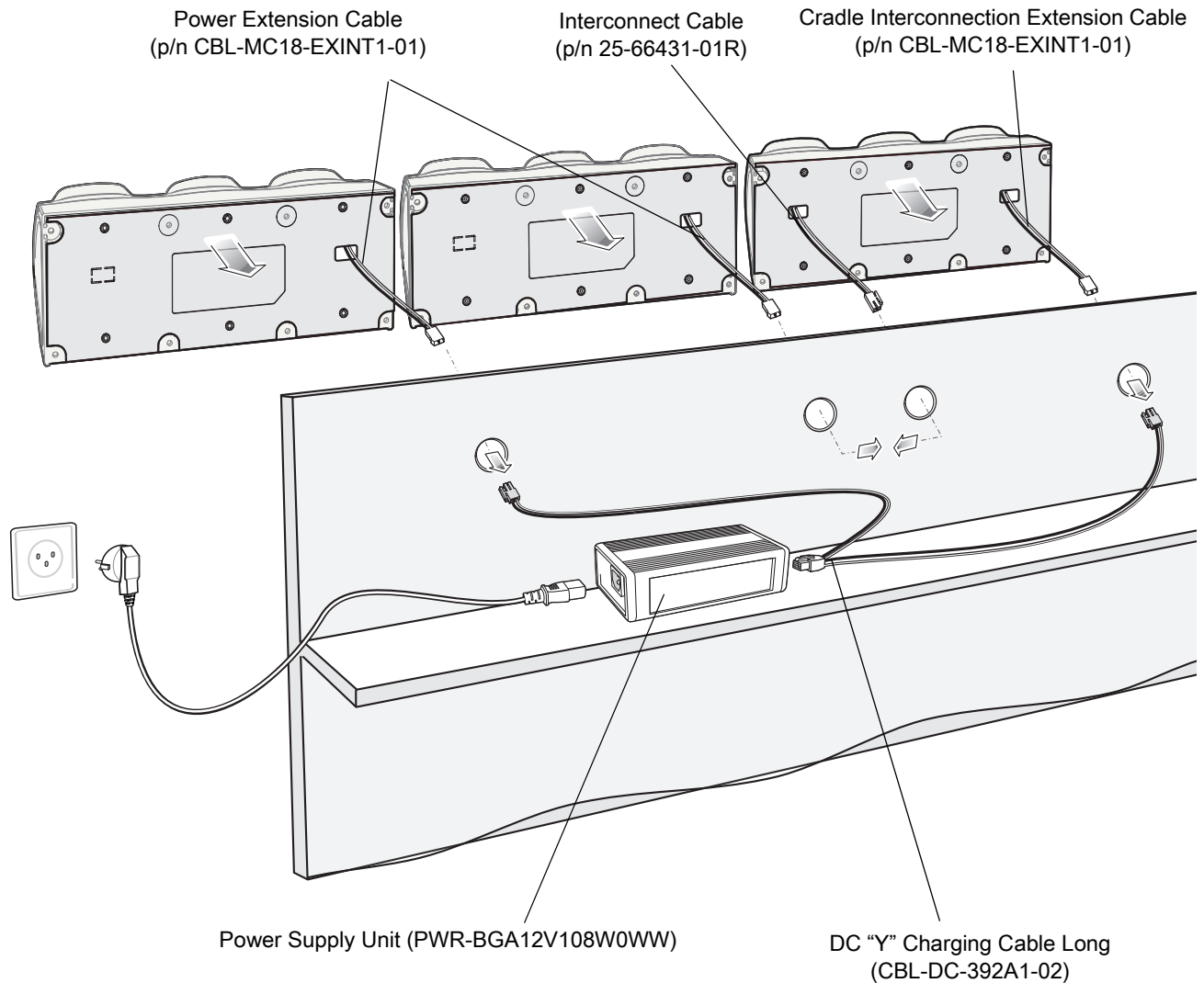

16. Place the socket onto the cradle and secure the four screws.

17. Place the socket cover onto the cradle and secure the two screws.

## Releasing the PS20 from the Charging Cradles

Use one of the following methods to release the PS20 from the charging cradles:

- Software Release Using the Menu
- Software Release Using the Cradle Utility
- Manual Release using a Release Key.



**NOTE:** Devices can also be removed via any customer application that used the EMDK personal shopper interface.

## Software Release Using the Menu

The PS20 cradles contain a locking mechanism that locks the PS20 inside the cradle when docked. The PS20 releases from the cradle when a software command is received from the system.

To remove the PS20 from the cradle using the menu:

1. Touch and hold the soft power button  until the menu appears.
2. Touch **Cradle unlock**. The cradle unlocks the PS20.
3. Remove the PS20 from the cradle.

## Software Release Using the Cradle Utility

The PS20 cradles contain a locking mechanism that locks the PS20 inside the cradle when docked. The PS20 releases from the cradle when a software command is received from the system.

To remove the PS20 from the cradle using the Cradle Utility:

1. On the Home screen, swipe up from the bottom of the screen.
2. Touch **CradleUtility**.
3. Tap the **CRADLE UNLOCK** tab to set the cradle unlock information.
4. Touch **Unlock Cradle**.

## Manual Release Using a Release Key

The PS20 cradles contain a locking mechanism that locks the PS20 inside the cradle when docked. If the PS20 fails to unlock during normal operation, use a release key (KT-MC18-CKEY-20) to unlock the PS20.



**CAUTION:** Do not use any device to unlock the cradle other than the tools described below. Failure to comply could result in damage to the cradle and void the warranty.

### Manual Release of the PS20 from the Single Slot Cradle

To release a locked PS20 from a Single Slot Cradle:

1. Insert the release key into the slot located at the bottom side of the cradle.
2. While pressing the release key all the way into the slot, remove the PS20 from the cradle.

Figure 81 Manual Release of PS20 from a Single Slot Cradle

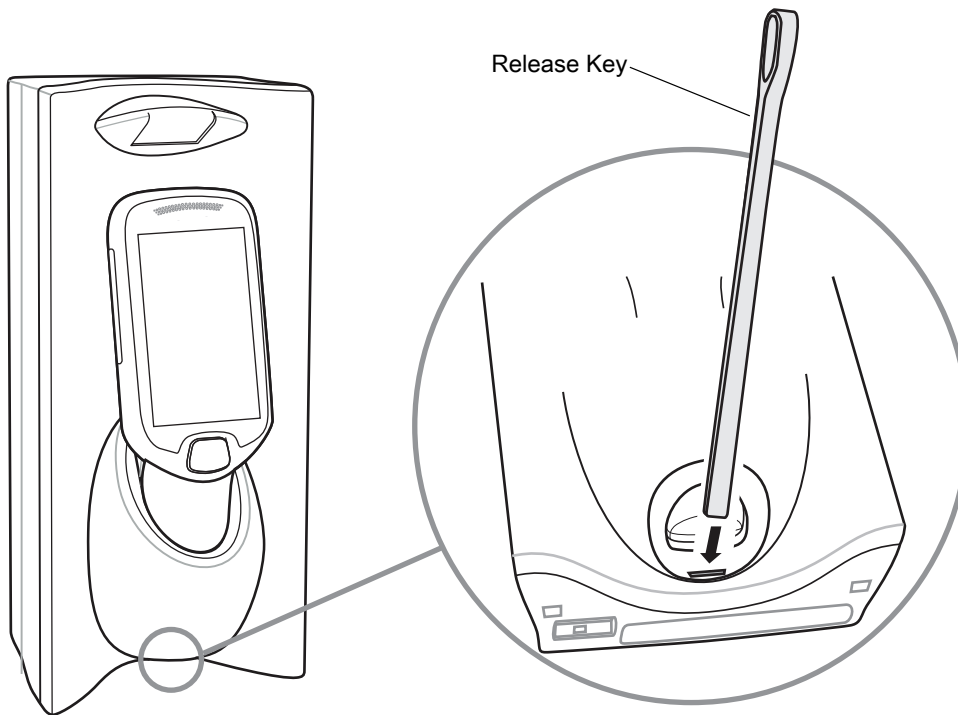

### Manual Release of the PS20 from the Three Slot Cradle

To release a locked PS20 from a Three Slot Cradle:

1. Insert the release key straight into the slot, to a point where the bend stops.
2. Hold the release key pressed inside the slot and remove the PS20 from the slot.

Figure 82 Manual Release of the PS20 from a Three Slot Cradle

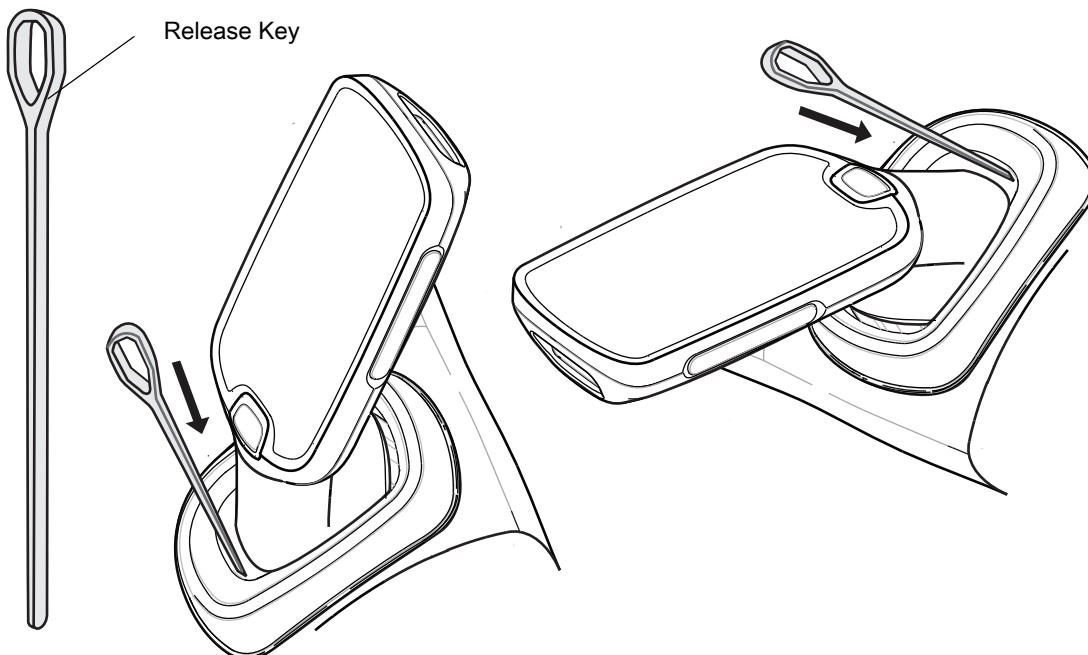



## USB Cable Battery Cover

### Installing the USB Cable Battery Cover

Use the USB Cable Battery Cover to connect the device to a host computer.

To install the USB Cable Battery Cover:

1. Remove the standard battery cover that comes installed on the device, if it is not already removed.
  - a. Loosen the captive screw that secures the battery cover, using a Phillips (PH00) screwdriver.
  - b. Lift the battery cover from the handle.
2. Slide the tab on the top of the USB Cable Battery Cover into the slot on the back of the device.

Figure 83 Install USB Cable Battery Cover - Top

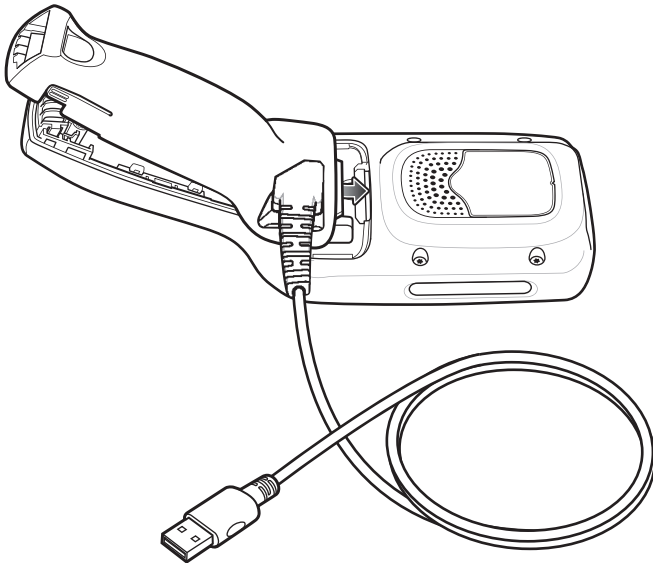

3. Push the bottom of the USB Cable Battery Cover down, until it snaps into place.

Figure 84 Install USB Cable Battery Cover - Bottom

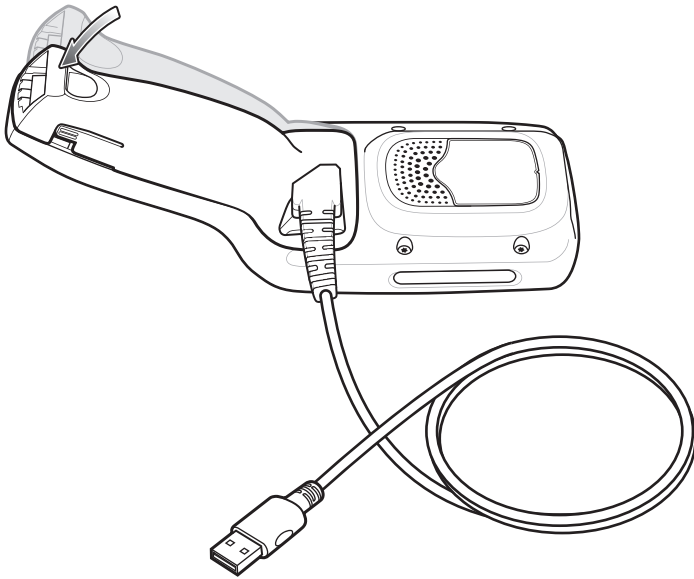

## Removing the USB Cable Battery Cover

To remove the USB Cable Battery Cover:

1. Squeeze the left and right tabs in on the bottom of the USB Cable Battery Cover.
2. Lift the bottom of the USB Cable Battery Cover up.
3. Slide the top of the USB Cable Battery Cover out to remove.

Figure 85 Remove USB Cable Battery Cover

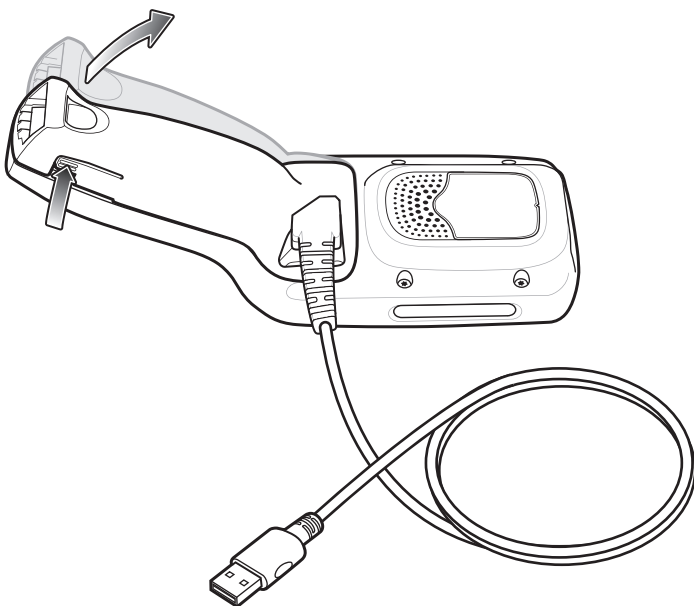

## Soft Holster

The soft holster provides a holder for the MC18/PS20 and allows for wearing the device on the hip, using a belt clip, or crossbody, using the detachable shoulder strap.

Always place the device with the correct orientation when using the soft holster with a belt clip or shoulder strap, as shown in the following diagrams.

### Using the Belt Clip

To attach the soft holster to a belt or waist band:

1. Secure the belt clip on the soft holster, if it is not already attached.

Figure 86 Secure Belt Clip on Soft Holster

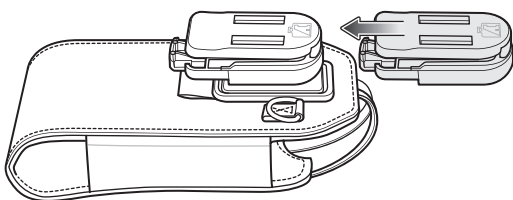

2. Secure the belt clip on the belt or waistband.

Figure 87 Secure Belt Clip on Belt

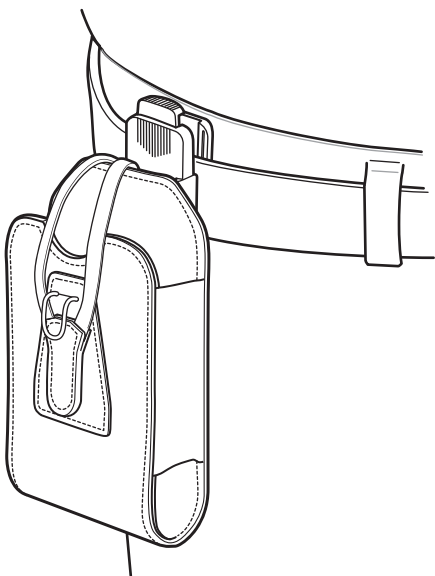

3. To insert the device, slide the device into the soft holster, with the screen facing the user.

Figure 88 Insert Device

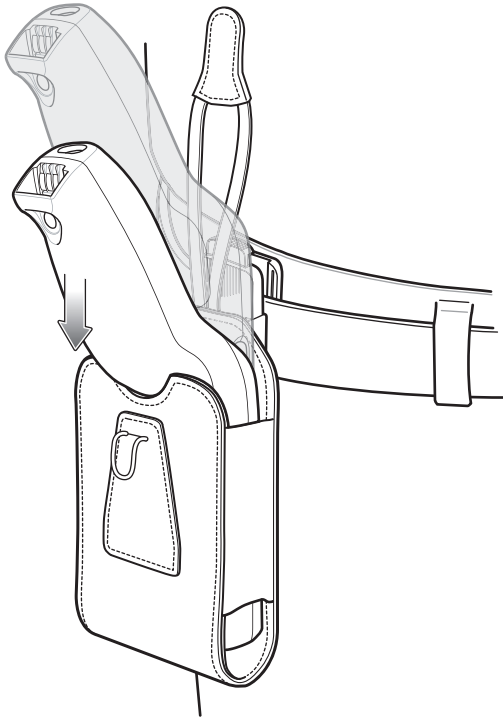

4. Secure the device with the restraining strap and place over the device and hook to secure in place.

Figure 89 Secure with Strap

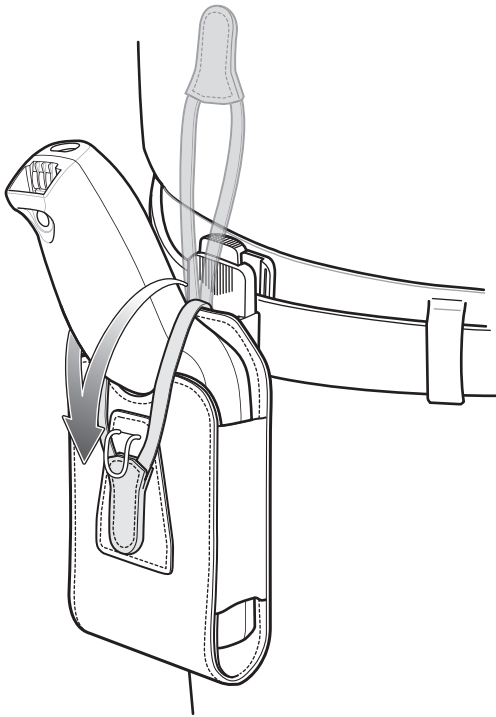

5. To remove the device, lift the restraining strap to release. Lift the device out of the soft holster.

## Using the Shoulder Strap

To attach the soft holster to a shoulder strap:

1. Connect the clips on the shoulder strap to the rings on the soft holster, if not already attached.
2. Place the shoulder strap over your head and rest on your shoulder.

Figure 90 Shoulder Strap



3. Lift the strap and insert the device into the soft holster, with the screen facing the user.
4. Secure the device with the restraining strap and place over the device and hook to secure in place.

# Application Deployment

## Introduction

This chapter describes features in Android including new security features, how to package applications, and procedures for deploying applications onto the device.

## Security

The device implements a set of security policies that determine whether an application is allowed to run and, if allowed, with what level of trust. To develop an application, you must know the security configuration of the device, and how to sign an application with the appropriate certificate to allow the application to run (and to run with the needed level of trust).



**NOTE:** Ensure the date is set correctly before installing certificates or when accessing secure web sites.

## Secure Certificates

If the VPN or Wi-Fi networks rely on secure certificates, obtain the certificates and store them in the device's secure credential storage, before configuring access to the VPN or Wi-Fi networks.

If downloading the certificates from a web site, set a password for the credential storage. The device supports X.509 certificates saved in PKCS#12 key store files with a .p12 extension (if key store has a .pfx or other extension, change to .p12).

The device also installs any accompanying private key or certificate authority certificates contained in the key store.

## Installing a Secure Certificate

To install a secure certificate:

1. Copy the certificate from the host computer to the root of the device's internal memory. See USB Communication for information about connecting the device to a host computer and copying files.
2. Go to **Settings**.
3. Touch **Security & location > Advanced > Encryption & credentials**.
4. Touch **Install from storage**.
5. Navigate to the location of the certificate file.

6. Touch the filename of the certificate to install.
7. If prompted, enter the password for credential storage. If a password has not been set for the credential storage, enter a password for it twice and then touch **OK**.
8. If prompted, enter the certificate's password and touch **OK**.
9. Enter a name for the certificate and in the Credential use drop-down, select **VPN and apps** or **Wi-Fi**.
10. Touch **OK**.

The certificate can now be used when connecting to a secure network. For security, the certificate is deleted from the internal memory.

### Configuring Credential Storage Settings

1. Go to **Settings**.
2. Touch **Security & location > Encryption & credentials**.
  - **Trusted credentials** - Touch to display the trusted system and user credentials.
  - **Install from storage** - Touch to install a secure certificate from the internal storage.
  - **Clear credentials** - Deletes all secure certificates and related credentials.

## Development Tools

### Android Application Development

#### Development Workstation

Android development tools are available at [developer.android.com](http://developer.android.com).

To start developing applications for the device, download Android Studio. Development can take place on a Microsoft® Windows®, Mac® OS X®, or Linux® operating system.

Applications are written in the Java language, but compiled and executed in the Dalvik virtual machine. Once the Java code is compiled cleanly, the developer tools make sure the application is packaged properly, including the AndroidManifest.xml file.

Android Studio contains a full featured IDE as well as SDK components required to develop Android applications.

#### Target Device

Open the **Developer options** screen to set development related settings.

By default, the Developer Options are hidden. To un-hide the developer options:

1. Go to **Settings**.
2. Touch **About phone**.
3. Scroll down to **Build number**.
4. Tap **Build number** seven times. The message **You are now a developer!** appears.
5. Touch .

6. Touch **System > Advanced > Developer options**.
7. Slide the **USB debugging** switch to the **ON** position.

### EMDK for Android

EMDK for Android provides developers with a comprehensive set of tools to easily create powerful line-of-business applications for enterprise mobile computing devices. It's designed for Google's Android SDK and Android Studio, and includes class libraries, sample applications with source code, and all associated documentation to help your applications take full advantage of what Zebra devices have to offer.

The kit also delivers Profile Manager, a GUI-based device configuration tool providing exclusive access to the Zebra MX device management framework. This allows developers to configure Zebra devices from within their applications in less time, with fewer lines of code and with fewer errors.

For more information go to: [techdocs.zebra.com](http://techdocs.zebra.com).

### StageNow

StageNow is Zebra's next-generation Android Staging Solution built on the MX platform. It allows quick and easy creation of device profiles, and can deploy to devices simply by scanning a bar code, reading a tag, or playing an audio file.

The StageNow Staging Solution includes the following components:

- The StageNow Workstation tool installs on the staging workstation (host computer) and lets the administrator easily create staging profiles for configuring device components, and perform other staging actions such as checking the condition of a target device to determine suitability for software upgrades or other activities. The StageNow Workstation stores profiles and other created content for later use.
- The StageNow Client resides on the device and provides a user interface for the staging operator to initiate staging. The operator uses one or more of the desired staging methods (print and scan a bar code, read an NFC tag or play an audio file) to deliver staging material to the device.

For more information go to: [techdocs.zebra.com](http://techdocs.zebra.com).

### MX Features

The following MX features are available in the Configuration Service Provider (CSP) Settings:

- Enable/Disable On Screen Power Button - available in MX 8.3 and later.
- Enable/Disable Navigation Bar - available in MX 7.1 and later.

**On Screen Power Button** - From StageNow, create a profile using the Xpert mode wizard (with MX 8.3 or later) and select UI Manager CSP Settings. Include the requirements to create a barcode and stage the device.

**Navigation Bar** - From StageNow, create a profile using the Xpert mode wizard (with MX 7.1 or later) and select Power Key Manager CSP Settings. Include the requirements to create a barcode and stage the device.

For more information go to: [techdocs.zebra.com](http://techdocs.zebra.com).



## GMS Restricted

GMS Restricted mode deactivates Google Mobile Services (GMS). All GMS apps are disabled on the device and communication with Google (analytics data collection and location services) is disabled.

Use StageNow to disable or enable GMS Restricted mode. After a device is in GMS Restricted mode, enable and disable individual GMS apps and services using StageNow. To ensure GMS Restricted mode persists after an Enterprise Reset, use the Persist Manager option in StageNow. For more information on StageNow, refer to [techdocs.zebra.com](http://techdocs.zebra.com).

## ADB USB Setup

To use the ADB, install the USB driver. This assumes that the development SDK has been installed on the host computer. Go to [developer.android.com/sdk/index.html](http://developer.android.com/sdk/index.html) for details on setting up the development SDK.

ADB driver for Windows and Linux are available on the Zebra Support Central web site at [www.zebra.com/support](http://www.zebra.com/support). Download the ADB and USB Driver Setup package. Following the instructions with the package to install the ADB and USB drivers for Windows and Linux.

## Enabling USB Debugging

By default, USB debugging is disabled. To enable USB debugging:

1. Go to **Settings**.
2. Touch **System > About phone**.
3. Scroll down to **Build number**.
4. Tap **Build number** seven times. The message **You are now a developer!** appears.
5. Touch .
6. Touch **Advanced > Developer options**.
7. Slide the **USB debugging** switch to the **ON** position.
8. Touch **OK**.
9. Connect the device to the host computer using the Rugged Charge/USB Cable.  
The **Allow USB debugging?** dialog box appears on the device.
10. On the device, touch **OK**.
11. On the host computer, navigate to the `platform-tools` folder.
12. Type `adb devices`.  
The following displays:  
**List of devices attached**  
`XXXXXXXXXXXXXXXX device` (where XXXXXXXXXXXXXXXXXXXX is the device number).



**NOTE:** If device number does not appear, ensure that ADB drivers are installed properly.

13. Touch .

## Application Installation

After an application is developed, install the application onto the device using one of the following methods:

- USB connection, see Installing Applications Using the USB Connection.
- Android Debug Bridge, see Installing Applications Using the Android Debug Bridge.
- Mobile device management (MDM) platforms that have application provisioning. Refer to the MDM software documentation for details.

### Installing Applications Using the USB Connection

1. Connect the device to a host computer using the Rugged Charge/USB cable.
2. Pull down the Notification panel and touch **USB for Charging**.
3. Touch **Transfer files**.
4. On the host computer, open a **Files** application.
5. On the host computer, copy the application .apk file from the host computer to the device.
6. Disconnect the device from the host computer.
7. Swipe the screen up and select  to view files on the Internal Storage.
8. Locate the application .apk file.
9. Touch the application file.
10. Touch **Continue** to install the app or **Cancel** to stop the installation.
11. To confirm installation and accept what the application affects, touch **Install** otherwise touch **Cancel**.
12. Touch **Open** to open the application or **Done** to exit the installation process. The application appears in the App list.

### Installing Applications Using the Android Debug Bridge

Use ADB commands to install application onto the device.

Ensure that the ADB drivers are installed on the host computer. See ADB USB Setup.

1. Connect the device to a host computer using USB. See USB Communication.
2. Go to **Settings**.
3. Touch **System > Advanced > Developer options**.
4. Slide the switch to the **ON** position.
5. Touch **USB Debugging**. A check appears in the check box. The **Allow USB debugging?** dialog box appears.
6. Touch **OK**.
7. On the host computer, open a command prompt window and use the adb command:  
`adb install <application>`  
 where: <application> = the path and filename of the apk file.

8. Disconnect the device from the host computer.

### Uninstalling an Application

To uninstall an application:

1. Go to **Settings**.
2. Touch **Apps & notifications**.
3. Touch **See all apps** to view all apps in the list.
4. Scroll through the list to the app.
5. Touch the app. The **App info** screen appears.
6. Touch **Uninstall**.
7. Touch **OK** to confirm.

### Performing a System Update

System Update packages can contain either partial or complete updates for the operating system. Zebra distributes the System Update packages on the Zebra Support & Downloads web site. Perform system update using ADB.

### Downloading the System Update Package

To download the system update package:

1. Go to the Zebra Support & Downloads web site, [www.zebra.com/support](http://www.zebra.com/support).
2. Download the appropriate System Update package to a host computer.

### Using ADB

To update the system using ADB:

1. Connect the device to the Rugged Charge/USB cable or insert the device into the 1-Slot USB/Charge Only Cradle.
2. Connect the cable or cradle to the host computer.
3. Go to **Settings**.
4. Touch **System > Advanced > Developer options**.
5. Slide the switch to the **ON** position.
6. Touch **USB Debugging**. A check appears in the check box. The **Allow USB debugging?** dialog box appears.
7. Touch **OK**.

8. On the host computer, open a command prompt window and use the adb command:

```
adb devices
```

The following displays:

```
List of devices attached
```

```
XXXXXXXXXXXXXXXX device (where XXXXXXXXXXXXXXXXXXXX is the device number).
```



**NOTE:** If device number does not appear, ensure that ADB drivers are installed properly.

9. Type:

```
adb reboot recovery
```

10. Press Enter. The System Recovery screen appears.

11. Tap the touch panel to advance to the next menu choice and navigate to **apply upgrade from adb**.



**IMPORTANT:** If **Apply downgrade from ADB** is selected, an Enterprise Reset is performed on whatever upgrade or downgrade package is provided.

12. Press the Power button.

13. Tap the touch panel to advance to the next menu choice and navigate to the **Full OTA Package** or **Diff OTA Package** file.

14. Press the Power button.

15. On the host computer command prompt window type:

```
adb sideload <file>
```

where: <file> = the path and filename of the zip file.

16. Press Enter. The System Update installs (progress appears as percentage in the Command Prompt window) and then the Recovery screen appears.

17. Press the Power button to reboot the device.



**NOTE:** If installing GMS software on a device that had Non-GMS software or Non-GMS software on a device that had GMS software, perform a Factory or Enterprise reset (retains enterprise data).

## Verify System Update Installation

To check that the system update installed properly:

1. Go to **Settings**.
2. Touch **System > About phone**.
3. Scroll down to **Build number**.
4. Ensure that the build number matches the new system update package file number.

## Performing an Enterprise Reset

An Enterprise Reset erases all user data in the /data partition, including data in the primary storage locations (/sdcard and emulated storage).

Before performing an Enterprise Reset, provision all necessary configuration files and restore after the reset.

Perform Enterprise Reset using ADB.

## Downloading the Enterprise Reset Package

To download the system update package:

1. Go to the Zebra Support & Downloads web site, [www.zebra.com/support](http://www.zebra.com/support).
2. Download the Enterprise Reset file to a host computer.

## Using ADB

To perform an Enterprise Reset using ADB:

1. Connect the device to the Rugged Charge/USB cable or insert the device into the 1-Slot USB/Charge Only Cradle.
2. Connect the cable or cradle to the host computer.
3. Go to **Settings**.
4. Touch **System > Advanced > Developer options**.
5. Slide the switch to the **ON** position.
6. Touch **USB Debugging**. A check appears in the check box. The **Allow USB debugging?** dialog box appears.
7. Touch **OK**.
8. On the host computer, open a command prompt window and type:  
**adb devices**.

The following displays:

**List of devices attached**

XXXXXXXXXXXXXXXXX device (where XXXXXXXXXXXXXXXXXXXX is the device number).



**NOTE:** If device number does not appear, ensure that ADB drivers are installed properly.

9. Type:  
**adb reboot recovery**
10. Press Enter. The System Recovery screen appears.
11. Tap the touch panel to advance to the next menu choice and navigate to **apply upgrade from adb**.
12. Press the Scan button.
13. Navigate to **Full OTA Package**.
14. Press the Scan button.
15. On the host computer command prompt window type:  
**adb sideload <file>**  
where: <file> = the path and filename of the zip file.
16. Press Enter. The Enterprise Reset package installs and then the Recovery screen appears.

17. Press the Scan button to reboot the device.

## Performing a Factory Reset

A Factory Reset erases all data in the `/data` and `/enterprise` partitions in internal storage and clears all device settings. A Factory Reset returns the device to the last installed operating system image. To revert to a previous operating system version, re-install that operating system image. See Performing a System Update for more information.

### Downloading the Factory Reset Package

To download the Factory Reset package:

1. Go to the Zebra Support & Downloads web site, [www.zebra.com/support](http://www.zebra.com/support).
2. Download the appropriate Factory Reset file to a host computer.

### Using ADB

To perform an Factory Reset using ADB:

1. Connect the device to the Rugged Charge/USB cable or insert the device into the 1-Slot USB/Charge Only Cradle.
2. Connect the cable or cradle to the host computer.
3. Go to **Settings**.
4. Touch **System > Advanced > Developer options**.
5. Slide the switch to the **ON** position.
6. Touch **USB Debugging**. A check appears in the check box. The **Allow USB debugging?** dialog box appears.
7. Touch **OK**.
8. On the host computer, open a command prompt window and use the adb command:  
**adb reboot recovery**
9. Press Enter. The System Recovery screen appears.
10. Tap the touch panel to advance to the next choice and navigate to **apply upgrade from adb**.
11. Press the Scan button.
12. On the host computer, open a command prompt window and use the adb command:  
**adb devices**.  
The following displays:  
**List of devices attached**  
**XXXXXXXXXXXXXXXX device** (where XXXXXXXXXXXXXXXXXXXX is the device number).



**NOTE:** If device number does not appear, ensure that ADB drivers are installed properly.

13.Type:

**adb reboot recovery**

14.Press Enter. The System Recovery screen appears.

15.Tap the touch panel to advance to the next choice and navigate to **apply upgrade from adb**.

16.Press the Scan button.

17.Navigate to **Full OTA Package**.

18.Press the Scan button.

19.On the host computer command prompt window type:

**adb sideload <file>**

where: <file> = the path and filename of the zip file.

20.Press Enter. The Factory Reset package installs and then the Recovery screen appears.

21.Press the Scan button to reboot the device.Replace the top cover.

## Storage

The device contains the following types of file storage:

- Random Access Memory (RAM)
- On-device Storage
- Internal storage
- Enterprise folder.

For more information, see Knowledge Articles - Best Practices in Mobile Computing: Flash at [zebra.com/ps20-info](http://zebra.com/ps20-info).

## Random Access Memory

Executing programs use RAM to store data. Data stored in RAM is lost upon a reset. The operating system manages how applications use RAM. It only allows applications and component processes and services to use RAM when required. It may cache recently used processes in RAM, so they restart more quickly when opened again, but it will erase the cache if it needs the RAM for new activities.

1. Go to **Settings**.
2. Touch **System > Advanced > Developer options > Memory**.

The screen displays the amount of used and free RAM.

- **Performance** - Indicates memory performance.
- **Total memory** - Indicates the total amount of RAM available.
- **Average used (%)** - Indicates the average amount of memory (as a percentage) used during the period of time selected (default - 3 hours).
- **Free** - Indicates the total amount of unused RAM.
- **Memory used by apps** - Touch to view RAM usage by individual apps.

## On Device Storage

The PS20 has On Device Storage. The On Device Storage content can be viewed and files copied to and from when the PS20 is connected to a host computer. Some applications are designed to be stored on the internal storage rather than in internal memory.

To view the used and available space on the On Device Storage:

1. Go to **Settings**.
2. Touch **Storage**.

## Internal Storage

The device has internal storage. The internal storage content can be viewed and files copied to and from when the device is connected to a host computer. Some applications are designed to be stored on the internal storage rather than in internal memory.

To view the used and available space on the internal storage:

1. Go to **Settings**.
2. Touch **Storage**.
  - **Internal Storage** - Displays the total amount of space on internal storage and amount used.

Touch **Internal shared storage** to display a the amount of storage used by apps, photos, videos, audio and other files.

## Enterprise Folder

The Enterprise folder (within internal flash) is a super-persistent storage that is persistent after a reset and an Enterprise Reset. The Enterprise folder is erased during a Factory Reset. The Enterprise folder is used for deployment and device-unique data. The Enterprise folder is approximately 128 MB (formatted). Applications can persist data after an Enterprise Reset by saving data to the enterprise/user folder. The folder is ext4 formatted and is only accessible from a host computer using ADB or from an MDM.

## App Management

Apps use two kinds of memory: storage memory and RAM. Apps use storage memory for themselves and any files, settings, and other data they use. They also use RAM when they are running.

1. Go to **Settings**.
2. Touch **Apps & notifications**.
3. Touch **See all XX apps** to view all apps on the device.
4. Touch **> Show system** to include system processes in the list.
5. Touch an app, process, or service in the list to open a screen with details about it and, depending on the item, to change its settings, permissions, notifications and to force stop or uninstall it.





## Viewing App Details

Apps have different kinds of information and controls, but commonly include:

- **Force stop** - stop an app.
- **Disable** - disable an app.
- **Uninstall** - remove the app and all of its data and settings from the device. See [Uninstalling an Application](#) for information about uninstalling apps.
- **Storage** - lists how much information is stored, and includes a button for clearing it.
- **Data usage** - provides information about data (Wifi) consumed by an app.
- **Permissions** - lists the areas on the device that the app has access to.
- **Notifications** - set the app notification settings.
- **Open by default** - clears If you have configured an app to launch certain file types by default, you can clear that setting here.
- **Battery** - lists the amount of computing power used by the app.
- **Memory** - lists the average app memory usage.
- Advanced
  - **Draw over other apps** - allows an app to display on top of other apps.

## Managing Downloads

Files and apps downloaded using the Browser or Email are stored on the Internal storage in the Download directory. Use the Downloads app to view, open, or delete downloaded items.

1. Swipe the screen up and touch .
2. Touch  > **Downloads**.
3. Touch and hold an item, select items to delete and touch . The item is deleted from the device.

# Maintenance and Troubleshooting

## Introduction

This chapter includes instructions on cleaning and storing the device, and provides troubleshooting solutions for potential problems during operation.

## Maintaining the Device

For trouble-free service, observe the following tips when using the device:

- In order to avoid scratching the screen, use the supplied stylus or plastic-tipped pens intended for use with a touch-sensitive screen. Never use an actual pen or pencil or other sharp object on the surface of the device screen.
- The touch-sensitive screen of the device is glass. Do not drop the device or subject it to strong impact.
- Protect the device from temperature extremes. Do not leave it on the dashboard of a car on a hot day, and keep it away from heat sources.
- Do not store the device in any location that is dusty, damp, or wet.
- Use a soft lens cloth to clean the device. If the surface of the device screen becomes soiled, clean it with a soft cloth moistened with an approved cleanser. For a list of approved cleansers, see Approved Cleanser Active Ingredients.
- Periodically replace the rechargeable battery to ensure maximum battery life and product performance. Battery life depends on individual usage patterns.

## Battery Safety Guidelines

- The area in which the units are charged should be clear of debris and combustible materials or chemicals. Particular care should be taken where the device is charged in a non commercial environment.
- Follow battery usage, storage, and charging guidelines found in this guide.
- Improper battery use may result in a fire, explosion, or other hazard.
- To charge the mobile device battery, the ambient battery and charger temperatures must be between +32°F and +104°F (0°C and +40°C).
- Do not use incompatible batteries and chargers, including non-Zebra batteries and chargers. Use of an incompatible battery or charger may present a risk of fire, explosion, leakage, or other hazard. If you have any questions about the compatibility of a battery or a charger, contact the Global Customer Support Center.

- For devices that utilize a USB port as a charging source, the device shall only be connected to products that bear the USB-IF logo or have completed the USB-IF compliance program.
- Do not disassemble or open, crush, bend or deform, puncture, or shred battery.
- Severe impact from dropping any battery-operated device on a hard surface could cause the battery to overheat.
- Do not short circuit a battery or allow metallic or conductive objects to contact the battery terminals.
- Do not modify or remanufacture, attempt to insert foreign objects into the battery, immerse or expose to water or other liquids, or expose to fire, explosion, or other hazard.
- Do not leave or store the equipment in or near areas that might get very hot, such as in a parked vehicle or near a radiator or other heat source. Do not place battery into a microwave oven or dryer.
- Battery usage by children should be supervised.
- Please follow local regulations to properly dispose of used re-chargeable batteries.
- Do not dispose of batteries in fire.
- In the event of a battery leak, do not allow the liquid to come in contact with the skin or eyes. If contact has been made, wash the affected area with water for 15 minutes and seek medical advice.
- If you suspect damage to your equipment or battery, contact Customer Support to arrange for inspection.

## Long Term Storage

When storing the device for a long period of time, it is recommended to remove the battery. When returning the device to everyday operation, install a fully charged battery.

## Cleaning Instructions



**CAUTION:** Always wear eye protection.

Read warning label on alcohol product before using.

If you have to use any other solution for medical reasons please contact the Global Customer Support Center for more information.



**WARNING:** Avoid exposing this product to contact with hot oil or other flammable liquids. If such exposure occurs, unplug the device and clean the product immediately in accordance with these guidelines.

## Approved Cleanser Active Ingredients

100% of the active ingredients in any cleaner must consist of one or some combination of the following: isopropyl alcohol, ammonium chloride or mild dish soap.



**IMPORTANT:** Use pre-moistened wipes and do not allow liquid cleaner to pool.

Approved cleansers include:

- Purell Ethanol Wipes
- 409 Glass Cleaner
- Windex Blue

### Harmful Ingredients

The following chemicals are known to damage the plastics on the device and should not come in contact with the device: acetone; ketones; ethers; aromatic and chlorinated hydrocarbons; aqueous or alcoholic alkaline solutions; ethanolamine; toluene; trichloroethylene; benzene; carboic acid and TB-lysoform.

Many vinyl gloves contain phthalate additives, which are often not recommended for medical use and are known to be harmful to the housing of the device.

Cleaners that are not approved include:

- Clorox Disinfecting Wipes
- Hydrogen Peroxide Cleaners
- Bleach Products.

### Device Cleaning Instructions

Do not apply liquid directly to the device. Dampen a soft cloth or use pre-moistened wipes. Do not wrap the device in the cloth or wipe, but gently wipe the unit. Be careful not to let liquid pool around the display window or other places. Allow the unit to air dry before use.



**NOTE:** For thorough cleaning, it is recommended to first remove all accessory attachments, such as hand straps or cradle cups, from the mobile device and to clean them separately.

### Special Cleaning Notes

The device should not be handled while wearing vinyl gloves containing phthalates, or before hands are washed to remove contaminant residue after gloves are removed.

If products containing any of the harmful ingredients listed above are used prior to handling the device, such as hand sanitizer that contain ethanolamine, hands must be completely dry before handling the device to prevent damage to the device.



**IMPORTANT:** If the battery connectors are exposed to cleaning agents, thoroughly wipe off as much of the chemical as possible and clean with an alcohol wipe. It is also recommended to install the battery in the terminal prior to cleaning and disinfecting the device to help minimize buildup on the connectors.

When using cleaning/disinfectant agents on the device, it is important to follow the directions prescribed by the cleaning/disinfectant agent manufacturer.

### Cleaning Materials Required

- Alcohol wipes
- Lens tissue
- Cotton-tipped applicators
- Isopropyl alcohol
- Can of compressed air with a tube.

## Cleaning Frequency

The cleaning frequency is at the customer's discretion due to the varied environments in which the mobile devices are used and may be cleaned as frequently as required. When dirt is visible, it is recommended to clean the mobile device to avoid build up of particles which make the device more difficult to clean later on.

For consistency and optimum image capture, it is recommended to clean the camera window periodically especially when used in environments prone to dirt or dust.

## Cleaning the Device

### Housing

Thoroughly wipe the housing, including all buttons and triggers, using an approved alcohol wipe.

### Display

The display can be wiped down with an approved alcohol wipe, but care should be taken not to allow any pooling of liquid around the edges of the display. Immediately dry the display with a soft, non-abrasive cloth to prevent streaking.

### Camera and Exit Window

Wipe the camera and exit window periodically with a lens tissue or other material suitable for cleaning optical material such as eyeglasses.

## Cleaning Battery Connectors

To clean the battery connectors:

1. Remove the main battery from the mobile computer.
2. Dip the cotton portion of the cotton-tipped applicator in isopropyl alcohol.
3. To remove any grease or dirt, rub the cotton portion of the cotton-tipped applicator back-and-forth across the connectors on the battery and terminal sides. Do not leave any cotton residue on the connectors.
4. Repeat at least three times.
5. Use a dry cotton-tipped applicator and repeat steps 3 and 4. Do not leave any cotton residue on the connectors.
6. Inspect the area for any grease or dirt and repeat the cleaning process if necessary.



**CAUTION:** After cleaning the battery connectors with bleach-based chemicals, follow the Battery Connector Cleaning instructions to remove bleach from the connectors.

## Cleaning Cradle Connectors

To clean the connectors on a cradle:

1. Remove the DC power cable from the cradle.
2. Dip the cotton portion of the cotton-tipped applicator in isopropyl alcohol.

3. Rub the cotton portion of the cotton-tipped applicator along the pins of the connector. Slowly move the applicator back-and-forth from one side of the connector to the other. Do not leave any cotton residue on the connector.
4. All sides of the connector should also be rubbed with the cotton-tipped applicator.
5. Remove any lint left by the cotton-tipped applicator.
6. If grease and other dirt can be found on other areas of the cradle, use a lint-free cloth and alcohol to remove.
7. Allow at least 10 to 30 minutes (depending on ambient temperature and humidity) for the alcohol to air dry before applying power to cradle.  
If the temperature is low and humidity is high, longer drying time is required. Warm temperature and low humidity requires less drying time.



**CAUTION:** After cleaning the cradle connectors with bleach-based chemicals, follow the Cleaning Cradle Connectors instructions to remove bleach from the connectors.

## Troubleshooting

### Resetting the Device

The reset functions include the following:

- Soft reset
- Hard reset
- Enterprise reset
- Full Factory reset.

#### Performing a Soft Reset

Perform a soft reset if applications stop working.

1. Press and hold the soft Power button until the menu appears.
2. Touch **Restart**.  
The device reboots.

#### Performing a Hard Reset



**CAUTION:** Perform a hard reset only if the device stops responding.

#### When in a Cradle

To perform a hard reset when the device is docked inside the cradle:

1. Ensure power is applied to the cradle.
2. Press and hold the Scan key for 10 seconds until the display powers off.
3. Release the Scan key.

4. Briefly press and release the Scan key.  
The device reboots.

### When Out of the Cradle

To perform a hard reset when the device is out of the cradle:

1. Insert the Terminal Reboot Tool into the Power Connector.

Figure 91 Terminal Reboot Tool

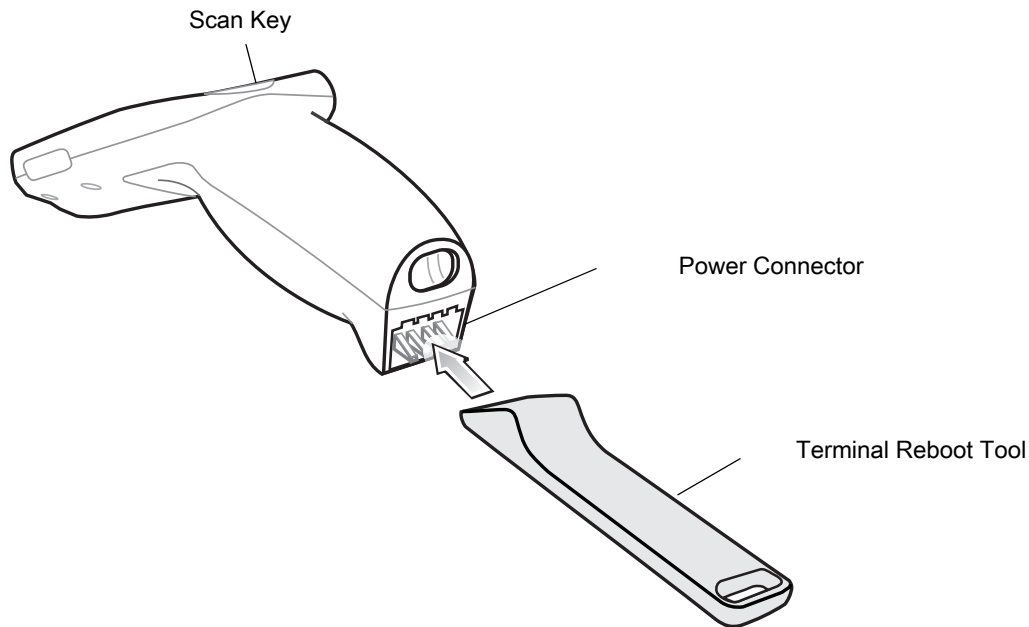

2. Press and hold the Scan key for 10 seconds until the display powers off.
3. Release the Scan key.
4. Remove the Terminal Reboot Tool.  
The device reboots.

## Entering into Recovery Mode

To enter into Recovery Mode:

1. Insert the Terminal Reboot Tool into the Power Connector.
2. Press and hold the Scan key for 10 seconds until the display powers off.
3. Hold the Scan key and Terminal Reboot Tool for three to four seconds after the device starts rebooting.
4. Remove the Terminal Reboot Tool and release the Scan key.
5. Wait for the device entering into the Recovery Mode.

PS20

Table 19 Troubleshooting the PS20

Problem	Cause	Solution
PS20 does not turn on.	Battery not charged.	Charge or replace the battery in the PS20.
	Battery not installed properly.	Ensure battery is installed properly. See <a href="#">Replacing the Battery on page 20</a> .
	System crash.	Perform a soft reset. If the PS20 still does not turn on, perform a hard reset. See <a href="#">Resetting the Device on page 46</a> .
Battery did not charge.	Battery failed.	Replace battery. If the PS20 still does not operate, try a soft reset, then a hard reset. See <a href="#">Resetting the Device on page 46</a> .
	PS20 removed from cradle before charging completed.	Insert the PS20 into the cradle and begin charging. The battery fully charges in approximately four hours.
	Ambient temperature of the cradle is too warm or too cold.	The ambient temperature must be between 0 °C and 40 °C (32 °F and 104 °F).
During data communication, no data was transmitted, or transmitted data was incomplete.	PS20 unplugged from host computer during communication.	Reconnect the programming cable to the host computer and re-transmit.
	Communication software was incorrectly installed or configured.	See system administrator.
PS20 turns itself off.	PS20 is inactive.	When the PS20 ships, by default, the Sleep period is <b>Never</b> . If the PS20 is running on battery power, this period can be changed to 15 seconds, 30 seconds, 1 minute, 2 minutes, 5 minutes, 10 minutes, or 30 minutes. The PS20 turns off after the set period of inactivity. Change the setting if you need a longer delay before the automatic shutoff feature activates.
	Battery is depleted.	Place the PS20 in the cradle to re-charge the battery.
	Battery is not inserted properly.	Insert the battery properly (see <a href="#">Replacing the Battery on page 20</a> ).
	The PS20's battery is low and it powers down to protect memory content.	Place the PS20 in the cradle to re-charge the battery.



Table 19 Troubleshooting the PS20 (Continued)

Problem	Cause	Solution
A message appears stating that the PS20 memory is full.	Too many files stored on the PS20.	Delete unused memos and records. You can save these records on the host computer.
	Too many applications installed on the PS20.	If you have installed additional applications on the PS20, remove them to recover memory. See <a href="#">Uninstalling an Application on page 127</a> .
The PS20 does not accept scan input.	Scanning application is not loaded.	Verify that the PS20 is loaded with a scanning application. See the System Administrator.
	Unreadable bar code.	Ensure the symbol is not defaced.
	Distance between imager exit window and bar code is incorrect.	Move the PS20 closer or further from the bar code to the proper scanning range.
	PS20 is not programmed for the bar code.	Verify that the PS20 can read the type of bar code being scanned (See Technical Specifications). Ensure that the bar code parameters are set properly for the bar code being scanned.
	PS20 is not programmed to generate a beep.	Verify that a beep on a good decode is used. See <a href="#">Barcode Input on page 161</a> for more information.
	Battery is low.	If the scanner is still not reading symbols, contact the distributor or service.
During USB data communications, no data was transmitted, or transmitted data was incomplete.	Incorrect cable connection.	See <a href="#">USB Communication</a> .
	Communications software is not installed or configured properly.	Perform setup as described in Cradle Installation. Ensure that a sync program is installed on the host computer.
Cannot sync with Host Computer	Host computer not configured properly.	Ensure that sync program on the host computer is set to allow USB connections. See <a href="#">USB Communication</a> for more information.

## Cradles

Table 20 Troubleshooting the Cradles

Symptom	Possible Cause	Solution
PS20 battery is not charging.	PS20 was removed from cradle or cradle was unplugged from AC power.	Ensure cradle is receiving power. Ensure PS20 is seated correctly. Confirm main battery is charging. The battery fully charges in approximately four hours.
	Battery is faulty.	Verify that other batteries charge properly. If so, replace the faulty battery (see Replacing the Battery on page 20).
	The PS20 is not fully seated in the cradle.	Remove and re-insert the PS20 into the cradle, ensuring it is firmly seated.
	Ambient temperature of the cradle is too warm or too cold.	Move the cradle to an area where the ambient temperature is between 0 °C and 40 °C (32 °F and 104 °F).
When the PS20 is placed in the cradle, the cradle LED does not blink.	Cradle is not powered.	Ensure cradle is receiving power.
	Cradle firmware is corrupted.	Contact system administrator.
	The PS20 is not operational.	Contact system administrator.
	Cradle - PS20 communication error.	Contact system administrator.
Cradle LED blinks red.	The cradle is issued an unlock command and it fails to unlock.	Contact system administrator.
	Cradle is overheating due to continuous lock/unlock or other cradle faults.	Contact system administrator.

# Specifications

## Introduction

For device technical specifications, go to [www.zebra.com/support](http://www.zebra.com/support).

## Data Capture Supported Symbologies

Table 21 Data Capture Supported Symbologies

Item	Description
ID Barcodes	Code 39, Code 128, Code 93, Codabar, MSI, UPC/EAN, Interleaved 2 of 5, RSS, Composite, TLC-39
2D Barcodes	PDF-417, Micro PDF-417, Composite, TLC-39, Datamatrix, DotCode, QR Code, Micro QRCode, Maxicode, Postal codes, Aztec Code, Han Xin

## Three Slot Cradle

Table 22 Cradle Specifications

Item	Description
Operating Temperature	0° C to +40° C (32° F to 104° F)
Storage Temperature	-20° C to 60° C (-4° F to 140° F)
Battery Charging Temperature	0° C to +40° C (32° F to 104° F) ambient temperature
Humidity	10% to 95% non-condensing
Size (H x L x W)	129 mm x 134 mm x 310 mm (5 in x 5.2 in x 12.2 in)
Weight	1550 g (54.67 oz)
Power Supply	12.0 VDC, 9.0 A
Electrostatic Discharge (ESD)	±15 k VDC air discharge, ± 8 k VDC contact discharge

## Single Slot Cradle

Table 23 Cradle Specifications

Item	Description
Operating Temperature	0° C to +40° C (32° F to 104° F)
Storage Temperature	-20° C to 60° C (-4° F to 140° F)
Battery Charging Temperature	0° C to +40° C (32° F to 104° F) ambient temperature
Humidity	10% to 95% non-condensing
Size (L x W x H)	98 mm x 127 mm x 272 mm (4 in. x 5 in. x 10.7 in.)
Weight	620 g (21.87 oz)
Power Supply	12.0 VDC, 9.0 A
Electrostatic Discharge (ESD)	±15 k VDC air discharge, ± 8 k VDC contact discharge

## PS20 Interface Connector Pin-Outs

Figure 92 Power Connector Pin-Outs

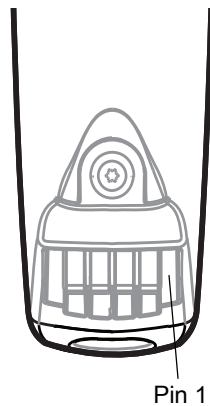

Table 24 Power Connector Pin-Outs

PIN	Signal Name	Function
1	+5V	Input power
2	TX	Transmit Output to Cradle
3	RX	Receive Input from Cradle
4	GND	Ground

## Cable Specifications

### Power Supply Cable, Y-type

Table 25 Wire Run List & Specifications

Wire Color	AWG	Connector 1 Molex 39-01-2060 housing; 4x, 39-00-0211 contacts	Connector 2 Molex 39-01-2025 housing; 2x, 39-00-0211 contacts	Connector 3 Molex 39-01-2025 housing; 2x, 39-00-0211 contacts	Function
Red	16	1	1		(+) term
Black	16	6	2		(-) term
Red	16	2		1	(+) term
Black	16	5		2	(-) term

The 16 AWG wire should have the following specifications: UL1007, 300 Volt, PVC, -40° C to 80° C operating temperature.

### Cradle Interconnection Cable

Table 26 Wire Run List & Specifications

Wire Color	AWG	Connector 1 Molex 39-01-2025 housing; 2x, 39-00-0211 contacts	Connector 2 Molex 39-01-2025 housing; 2x, 39-00-0211 contacts	Function
Red	16	1	1	(+) term
Black	16	2	2	(-) term

The 16 AWG wire should have the following specifications: UL1007, 300 Volt, PVC, -40° C to 80° C operating temperature.

# Index

## A

adaptive frequency hopping	90
ambient display setting	33
approved cleanser	135
approved cleanser active ingredients	135
apps	
accessing	45
battery manager	45
camera	48
Cradle Firmware Updater	52
Cradle Utility	55
datawedge demonstration	64
device central	65
diagnostic tool	68
Enterprise Browser	71
RxLogger	72
RxLogger Utility	73
Smart Cradle Configuration (CradleSmartConfig)	58
sound recorder	75

## B

battery	
charging	
temperature range	143, 144
low battery notification	30
monitor usage	29
battery management	29
battery level	29
battery present status	29
battery manager	45
battery optimization	30
battery safety guidelines	134
bluetooth	83, 90
change name	93
disabling	92
discovering devices	92
enabling	92
PIN	91
power states	91
profiles	91

security	90
----------	----

## C

camera	42, 48
front camera photo settings	50
front camera video settings	50
photo settings	50
recording videos	49
taking photos	48
video settings	50
camera settings	50
cast	94
change bluetooth name	93
charging	
temperature range	143, 144
cleaning	135, 136
battery connectors	137
camera and exit window	137
cradle connectors	137
display	137
frequency	137
housing	137
instructions	135
materials	136
cleaning instructions	136
configuration	11
cradle	
connector cleaning	137
Cradle Firmware Updater	52
Cradle Utility	55
controlling the cradle	55
performing cradle diagnostics	56
setting the cradle	56
viewing cradle information	57

## D

data capture	11
adjusting the distance	78
scanning	76
datawedge	80

decoders	80
disable	80
enable	80
datawedge demonstration	64
decoders	80
device central	65
my device tab	66
paging an RS6000 ring scanner	67
peripherals tab	66
scan and pair tab	65
unpairing a peripheral	66
diagnostic tool	68
battery test information	69
bluetooth test information	70
settings	69
system test information	70
wlan test information	70
disable bluetooth	92
disconnect host computer	31
discover bluetooth devices	92
display	11
display settings	32
display size	34

## E

EAP	83
enable bluetooth	92
Enterprise Browser	71
application	71

## F

file transfer	30
font size	34

## G

general sound setting	36
-----------------------	----

## H

harmful ingredients	136
home screen	24
rotation	25

## K

keyboards	
additional character tab	39
alpha tab	39
editing text	38
entering numbers, symbols, and special characters	38
numeric tab	39

## L

LED indicators	15
low battery notification	30

## M

main battery	
charging	
temperature range	143, 144
maintenance	134
approved cleanser active ingredients	135
battery safety guidelines	134
clean battery connectors	137
clean camera and exit window	137
clean cradle connectors	137
clean display	137
clean housing	137
cleaning frequency	137
cleaning instructions	135
cleaning materials required	136
device cleaning instructions	136
harmful ingredients	136
maintaining the device	134
special cleaning notes	136
managing notifications	27
memory	11
monitor battery usage	29

## N

notational conventions	11
notification icons	26
notifications	
managing	27

## O

operating system	11
------------------	----

## P

photo transfer	31
photos	
camera settings	50
taking	48
pin-outs	
mobile computer	144
powering on the device	22

## Q

quick access panel	28
quick settings	
edit icons	29

## R

radios	11
remove wi-fi	84
reset device	138
soft reset	138
RxLogger	72
configuration	72
configuration file	72
disable logging	72
enable logging	72
extract log files	73
RxLogger Utility	73

## S

scanning	
bar codes	76
considerations	76
screen	
Symbol splash screen	22
screen font size	34
screen rotation	32, 33
screen saver	
configure settings	35
setting	34
security	83
service information	12
setting	
camera	50
settings	32, 84
accessing	32, 84
ambient display	33
camera photos	50
camera videos	50
display	32
general sound	36
setup	17
Smart Cradle Configuration (CradleSmartConfig)	58
soft reset	138
software version	12
sound recorder	75
status bar	25

## T

temperature	
battery charging	143, 144
transferring files using USB	30
troubleshooting	138

## U

USB	30
-----	----

## V

videos	
camera settings	50
recording	49

## W

WEP	83
wi-fi	
advanced features	89
Wi-Fi direct	89
wireless local area network	83
WLAN	83
WPA	83



